

## 13. CR

### CR, CRI, CRN 1, 3

#### 50/60 Hz

##### Coupling guard

Description	Kit No
MG 71 - 80	96505130
MG 90 - 132	96505131
NEMA, F 182/213 TC	96505132

##### Content

Pos.	Description	Quantity
7	Coupling guard	2
7a	Screw	4

##### Plug

Description	Kit No
EPDM/FKM	96505133
EPDM/FKM, NEMA	96511103

##### Content

Pos.	Description	Quantity	
18	Vent screw	1	
23a	Pipe plug	1	
23b	Pipe plug	1	
25	Drain plug with bypass valve	1	
38	O-ring 16.3 x 2.4	EPDM	1
		FKM	1
100	O-ring 16.3 x 2.4	EPDM	2
		FKM	2

##### O-ring

Description	Kit No
EPDM	96455090
FKM	96455091
FXM	96463944

##### Wear parts

Pos.	Bearings	Kit No			
		96455095	96455092	96455093	96455094
	Silicon carbide				
	Bronze	96455102	96455104	96455105	96455106
	Carbon graphite	96460140	96455110	96455111	96455112
	Description/stages	-9	-19	-27	-36
4a	Chamber with bearing	1	2	3	4
39	Gasket	2	2	2	2
45	Neck ring	8	17	24	32
47a	Bearing ring, rotating	1	2	3	4
64a	Spacing pipe	1	2	3	4
64c	Clamp splined	1	1	1	1
65	Neck ring retainer	8	17	24	32
66	Lock washer	1	1	1	1
67	Lock nut	1	1	1	1

##### Content

Pos.	Description	Quantity
37	O-ring 137.5 x 3.3	2
38	O-ring 16.3 x 2.4	1
100	O-ring 16.3 x 2.4	2
109	O-ring 22 x 2.75	1

##### Shaft seal

Description	Kit No
HQQE	96455086
HQQV	96455087
HQQK	96533326
HQQF	96533327
HQBE	96455088
HQBV	96455089
HQBK	96491375
HUBE	96455082
HUBV	96455083
HUBK	96533322
HUBF	96533323
HUUE	96455084
HUUV	96455085
HUUV <sup>4)</sup>	91043611
HUUK	96533324
HUUF	96533325

4) Silicone-free cartridge

##### Content

Pos.	Description	Quantity
105	Shaft seal	1

CR, CRI, CRN 1, 3

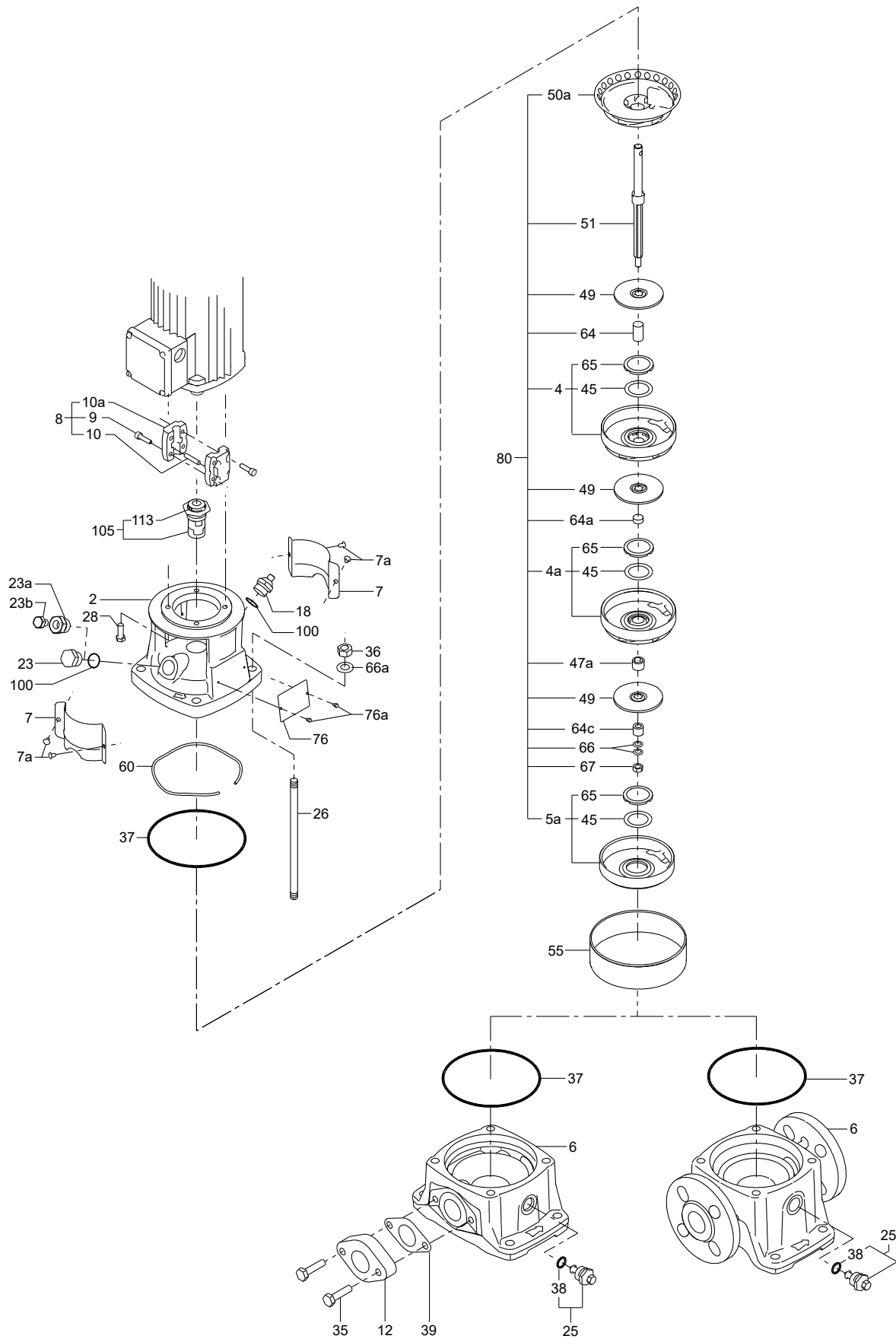

TM020210

**Chamber stack complete (silicon-carbide bearing)**

Pump type	CR/CRI 1	CRN 1	CR/CRI 3	CRN 3
Number of stages	Kit No	Kit No	Kit No	Kit No
2	96453485	96453507	96453529	96453552
3	96453486	96453508	96453530	96453553
4	96453487	96453509	96453531	96453554
5	96453488	96453510	96453532	96453555
6	96453489	96453511	96453533	96453556
7	96453490	96453512	96453534	96453557
8	96453491	96453513	96453535	96453558
9	96453492	96453514	96453536	96453559
10	96453493	96453515	96453537	96453560
11	96453494	96453516	96453538	96453561
12	96453495	96453517	96453539	96453562
13	96453496	96453518	96453540	96453563
15	96453497	96453519	96453541	96453564
17	96453498	96453520	96453542	96453565
19	96453499	96453521	96453543	96453566
21	96453500	96453522	96453544	96453567
23	96453501	96453523	96453545	96453568
25	96453502	96453524	96453546	96453569
27	96453503	96453525	96453547	96453570
29	-	-	96453548	96453571
30	96453504	96453526	-	-
31	-	-	96453549	96453572
33	96453505	96453527	96453550	96453573
36	96453506	96453528	96453551	96453574

**Coupling complete**

Motor/pump shaft diameter [mm]	Kit No
14/12	415060
19/12	415061
24/12	415062
28/12	415063
38/12	415065
15.8/12, NEMA	415314
28.5/12, NEMA	415315

**Content**

Pos.	Description	Quantity
9	Screw	4
10	Pin	1
10a	Coupling half	2

CR, CRI, CRN 1, 3

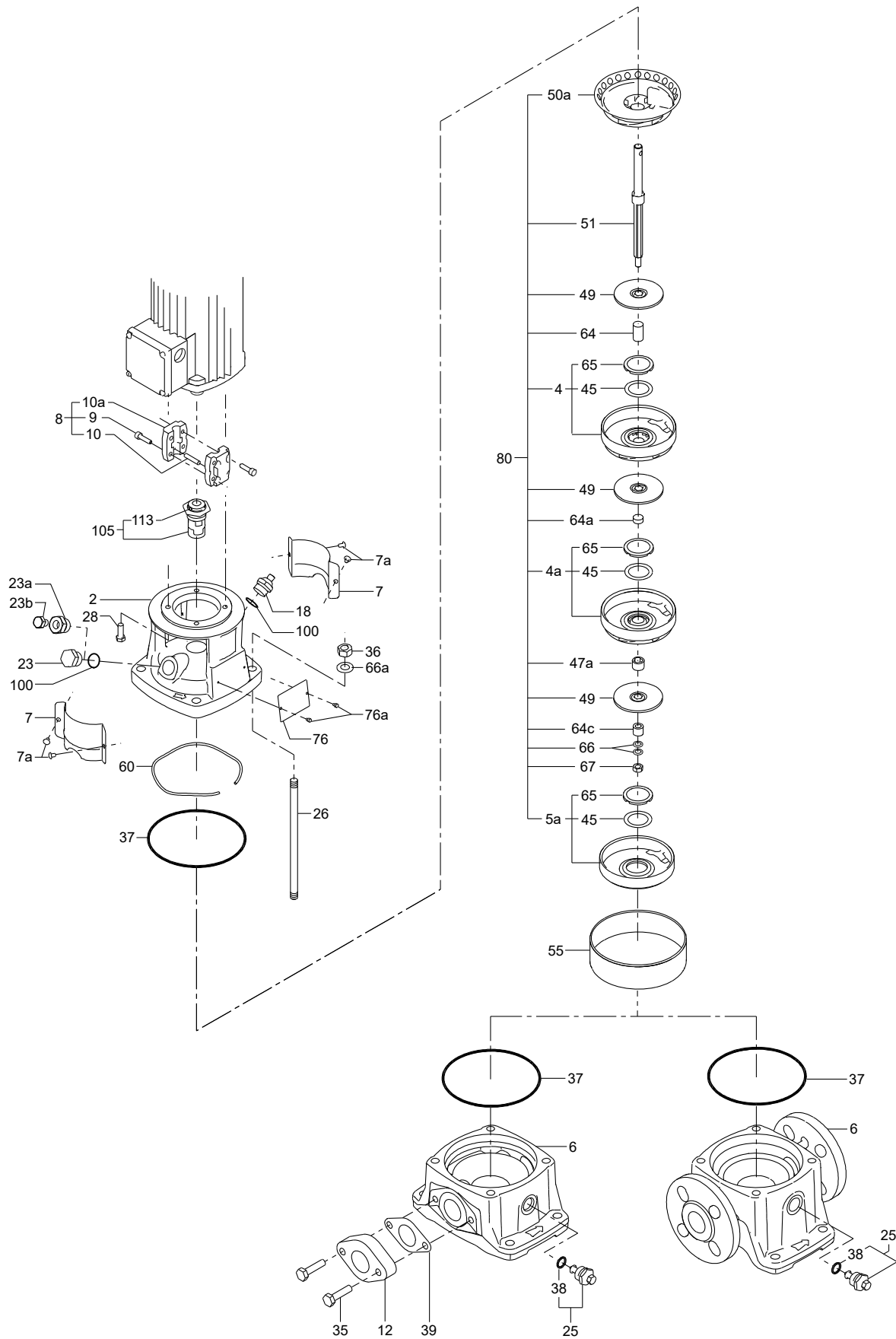

TM020210

**CR 2****50/60 Hz, models C, D****Chamber stack complete**

Consists of items: 4, 4a, 5a, 47a, 49, 50a, 51, 61, 64, 64a, 64c, 66, 67		
Number of stages	Kit No	Kit No
	Ceramic bearings	Bronze bearings
2	405102	405321
3	405103	405322
4	405104	405323
5	405105	405324
6	405106	405325
7	405107	405326
8	405115	405343
9	405108	405327
10	405116	405344
11	405109	405328
12	405117	405345
13	405110	405329
15	405111	405330
18	405112	405331
22	405113	405332
26	405114	405333

**Coupling complete**

Description	Kit No
14/12	415060
19/12	415060
24/12	415062
28/12	415063
38/12	415065
15.8/12	415314
28.5/12, NEMA	415315

Pos.	Description	Quantity
9	Screw	4
10	Pin	1

**Impeller**

Pos.	Kit No	Quantity
Description		
49	Impeller	2
64	Spacing pipe for impeller	2

**Content**

Pos.	Description	Quantity
8	Coupling half	2

**Shaft seal**

Pos.	Kit No	985167	405146	96588264	405096	405097	985727	985186	985720	985721	405348	405347
		Description	AUUE/V	AUUE/V	AUUE	BUBE	BUBV	RUUE/V	CVBV	AUUK	AUBK	BQQE
37	Sleeve gasket	2			2	2	2	2	2	2	2	2
37	Vulcanised sleeve gasket (NBR)	-	2	-	-	-	-	-	-	-	-	-
37	Vulcanised sleeve gasket (EPDM)	-	-	2	-	-	-	-	-	-	-	-
105	Shaft seal	1	1	1	1	1	1	1	1	1	1	1

## Wear parts

Pos.	Kit No	405098	405099	405100	96588266	405319	405320
	Number of stages	2-9	11-18	22-26	2-9	11-18	22-26
Description		Ceramic bearings			Bronze bearings		
4a	Bearing chamber	1	2	3	1	2	3
37	Sleeve gasket	2	2	2	2	2	2
38	Drain plug gasket	1	1	1	1	1	1
39	Flange gasket	2	2	2	2	2	2
45	Neck ring	8	14	23	8	14	23
47a	Bearing ring	1	2	3	1	2	3
61	Spacer for shaft seal	1	1	1	1	1	1
65	Neck ring retainer	8	14	23	8	14	23
64c	Spacer	1	1	1	1	1	1
66	Spring washer	1	1	1	1	1	1
67	Lock nut	1	1	1	1	1	1
68	O-ring (1 EPDM and 1 FKM)	1	1	1	1	1	1
100	O-ring (1 EPDM and 1 FKM)	1	1	1	1	1	1

CR 2

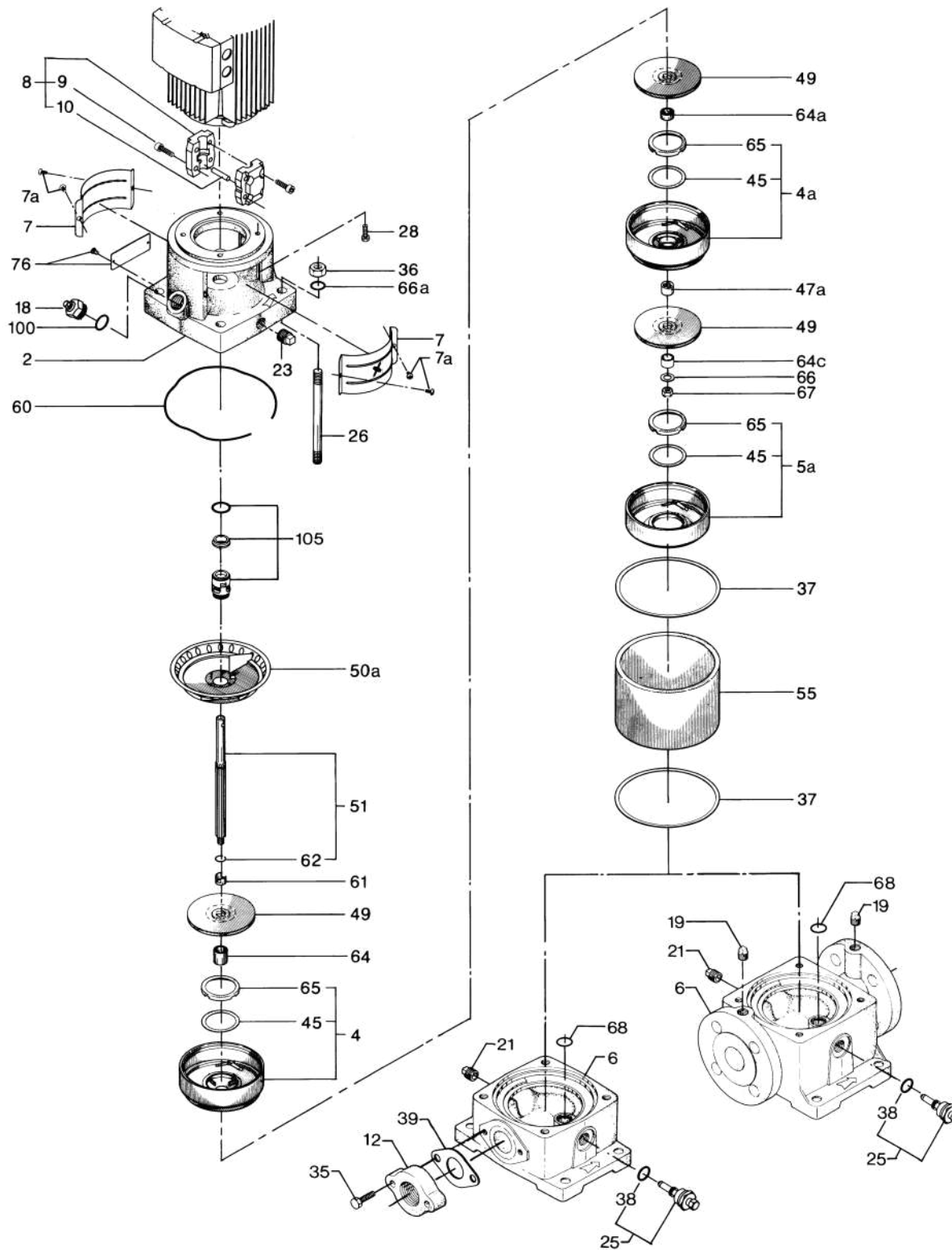

TM002559

**CR 4****50/60 Hz, models C, D****Chamber stack complete**

Consists of items: 4, 4a, 5a, 47a, 49, 50a, 51, 61, 64, 64a, 64c, 66, 66b, 67		
Number of stages	Kit No	Kit No
	Ceramic bearings	Bronze bearings
1	415254	415333
2	415255	415334
3	415256	415335
4	415257	415336
5	415258	415337
6	415259	415338
7	415260	415339
8	415261	415340
10	415262	415341
12	415263	415342
14	415264	415343
16	415265	415344
19	415266	415345
22	415267	415346

**Coupling complete**

Motor/pump shaft diameter [mm]	Kit No
14/12	415060
19/12	415061
24/12	415062
28/12	415063
38/12	415065
15.8/12, NEMA	415314
28.5/12, NEMA	415315

**Content**

Pos.	Description	Quantity
8	Coupling half	2

Pos.	Description	Quantity
9	Screw	4
10	Pin	1

**Impeller**

Pos.	Kit No	Quantity
Description		
	415232	
49	Impeller	2
64	Spacing pipe for impeller	2



**Shaft seal**

Pos.	Kit No	985167	405146	985769	405096	405097	985727	985186	985720	985721	405348	405347
	Description	AUUE/V	AUUE/V	AUUE	BUBE	BUBV	RUUE/V	CVBV	AUUK	AUBK	BQQE	BQQV
37	Sleeve gasket	2	-	-	2	2	2	2	2	2	2	2
37	Vulcanised sleeve gasket (NBR)	-	2	-	-	-	-	-	-	-	-	-
37	Vulcanised sleeve gasket (EPDM)	-	-	2	-	-	-	-	-	-	-	-
105	Shaft seal	1	1	1	1	1	1	1	1	1	1	1

**Wear parts**

Pos.	Kit No	415286	415287	415349	415288	415350	415351	415352	415353
	Number of stages	1-6	7-12	14-16	19-22	1-6	7-12	14-16	19-22
Description		Ceramic bearings				Bronze bearings			
4a	Bearing chamber	1	2	3	4	1	2	3	4
37	Sleeve gasket	2	2	2	2	2	2	2	2
38	Drain plug gasket	1	1	1	1	1	1	1	1
39	Flange gasket	2	2	2	2	2	2	2	2
45	Neck ring	5	10	13	18	5	10	13	18
47a	Bearing ring	1	2	3	4	1	2	3	4
61	Spacer for shaft seal	1	1	1	1	1	1	1	1
64c	Spacer	1	1	1	1	1	1	1	1
65	Neck ring retainer	5	10	13	18	5	10	13	18
66	Spring washer	1	1	1	1	1	1	1	1
67	Lock nut	1	1	1	1	1	1	1	1
68	O-ring	1	1	1	1	1	1	1	1
100	O-ring <sup>5)</sup>	1	1	1	1	1	1	1	1

5) EPDM and FKM

CR 4

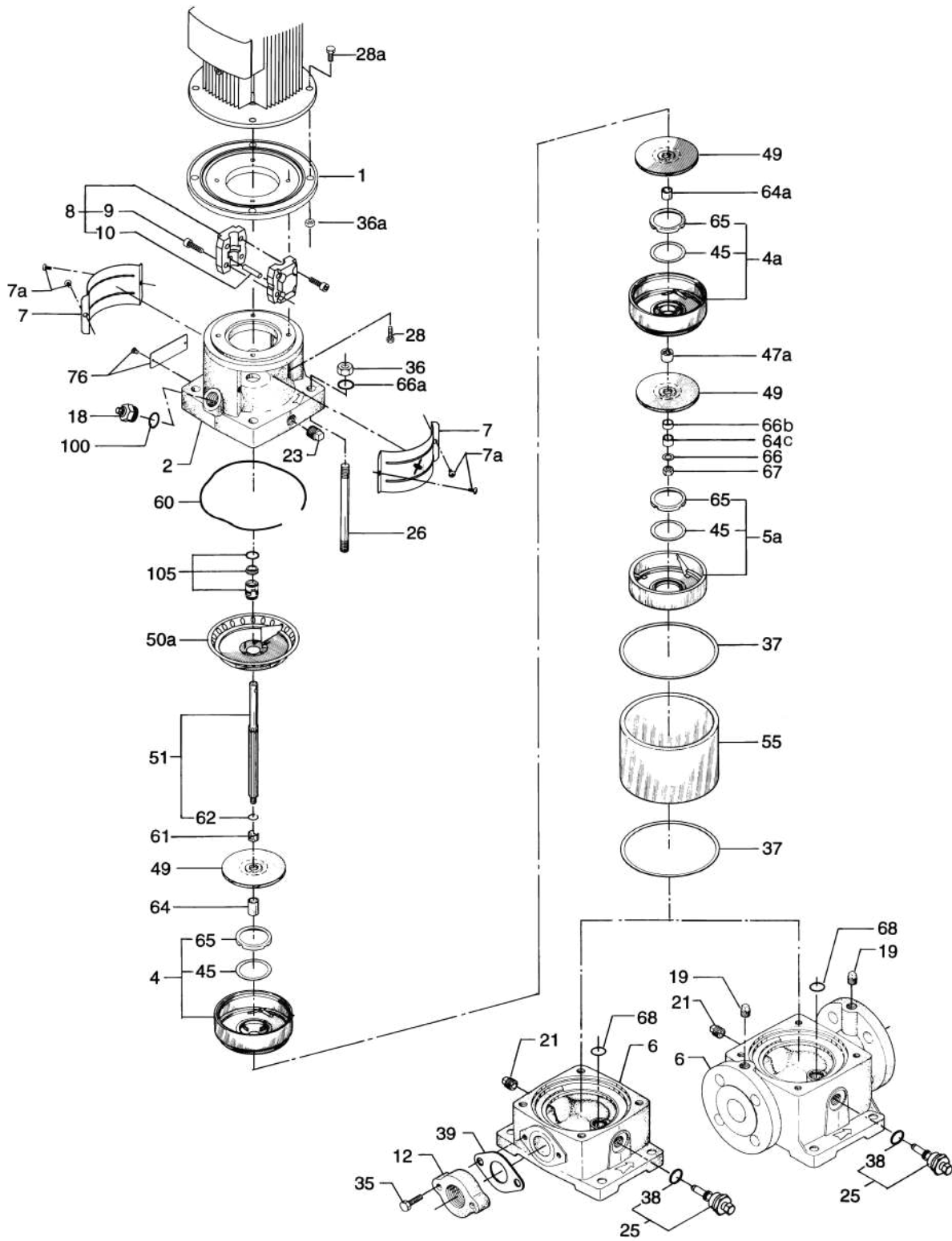

TM0002570

**CR, CRI, CRN 5****50/60 Hz****Coupling complete**

Motor/pump shaft diameter [mm]	Kit No
14/12	415060
19/12	415061
24/12	415062
28/12	415063
38/12	415065
15.8/12 (NEMA)	415314
28.5/12 (NEMA)	415315
34.9/12 (NEMA)	96478700

**Content**

Pos.	Description	Quantity
105	Shaft seal	1

**O-ring**

Pos.	Kit No	96455090	96455091
	Description	EPDM	FKM
37	O-ring 137.5 x 3.3	2	2
38	O-ring 16.3 x 2.4	1	1
100	O-ring 16.3 x 2.4	2	2
109	O-ring 22 x 2.75	1	1

**Wear parts**

Pos.	Bearings	Kit No					
		96455096	96455097	96455098	96455099	96455101	96455100
	<b>Silicon carbide</b>						
	<b>Bronze</b>	96455103	96460106	96455107	96455108	96460107	96455109
	<b>Carbon graphite</b>	96460141	96460142	96455113	96455114	96460143	96455115
	<b>Description/stages</b>	<b>-7</b>	<b>-12</b>	<b>-16</b>	<b>-22</b>	<b>.26</b>	<b>-36</b>
4a	Chamber with bearing	1	2	3	4	5	6
39	Gasket	2	2	2	2	2	2
45	Neck ring	6	10	13	18	21	30
47a	Bearing ring, rotating	1	2	3	4	5	6
64a	Spacing pipe	1	2	3	4	5	6
64c	Clamp splined	1	1	1	1	1	1
65	Neck ring retainer	6	10	13	18	21	30
66	Lock washer	1	1	1	1	1	1
67	Lock nut	1	1	1	1	1	1

**Shaft seal**

Description	Kit No
HQQE	96455086
HQQV	96455087
HQQK	96533326
HQQF	96533327
HQBE	96455088
HQBV	96455089
HQBK	96491375
HUBE	96455082
HUBV	96455083
HUBK	96533322
HUBF	96533323
HUUE	96455084
HUUV	96455085
HUUV <sup>6)</sup>	91043611
HUUK	96533324
HUUF	96533325

6) Silicone-free cartridge

**Content**

Pos.	Description	Quantity
105	Shaft seal	1

CR 5

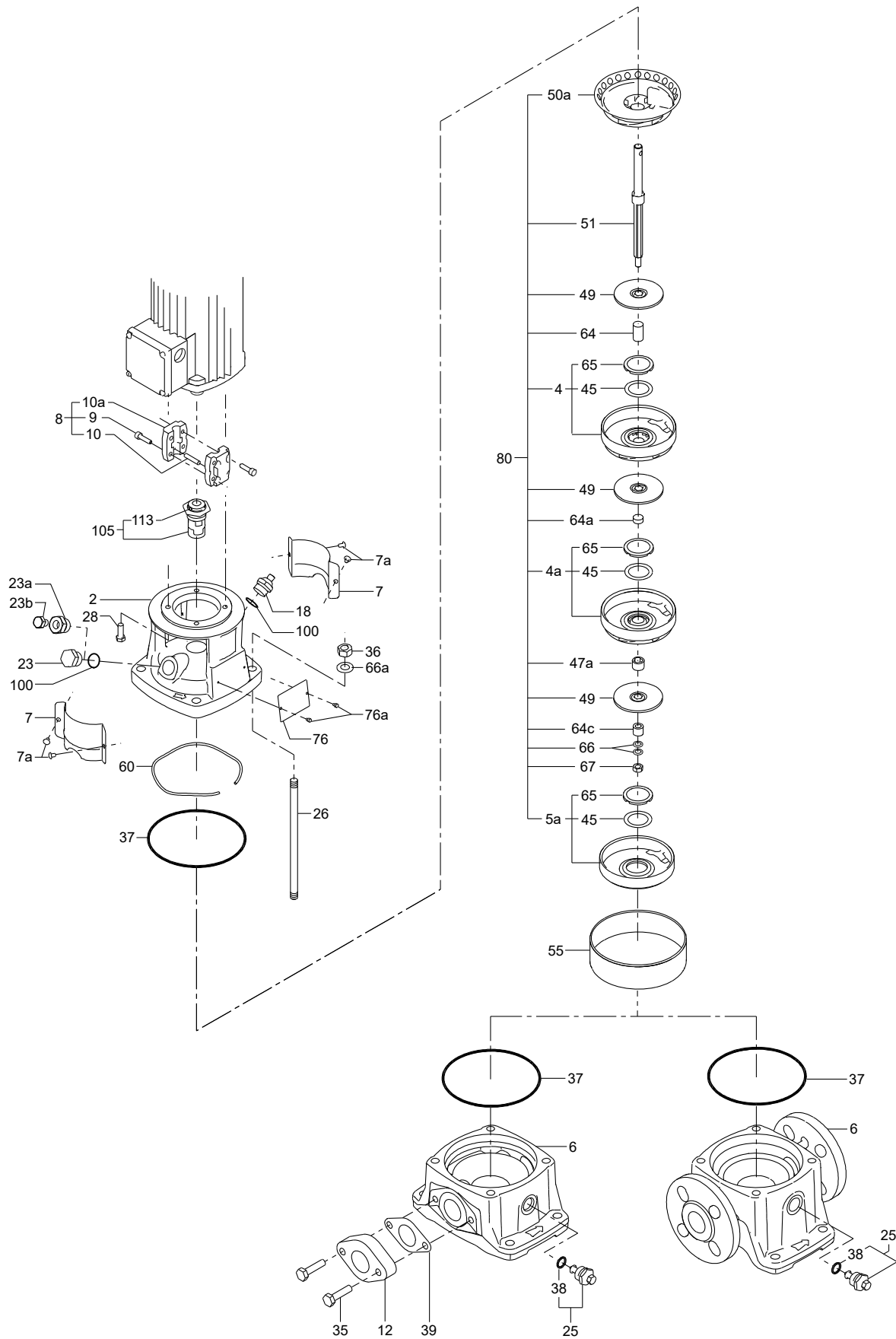

TM020210

CRI, CRN 5

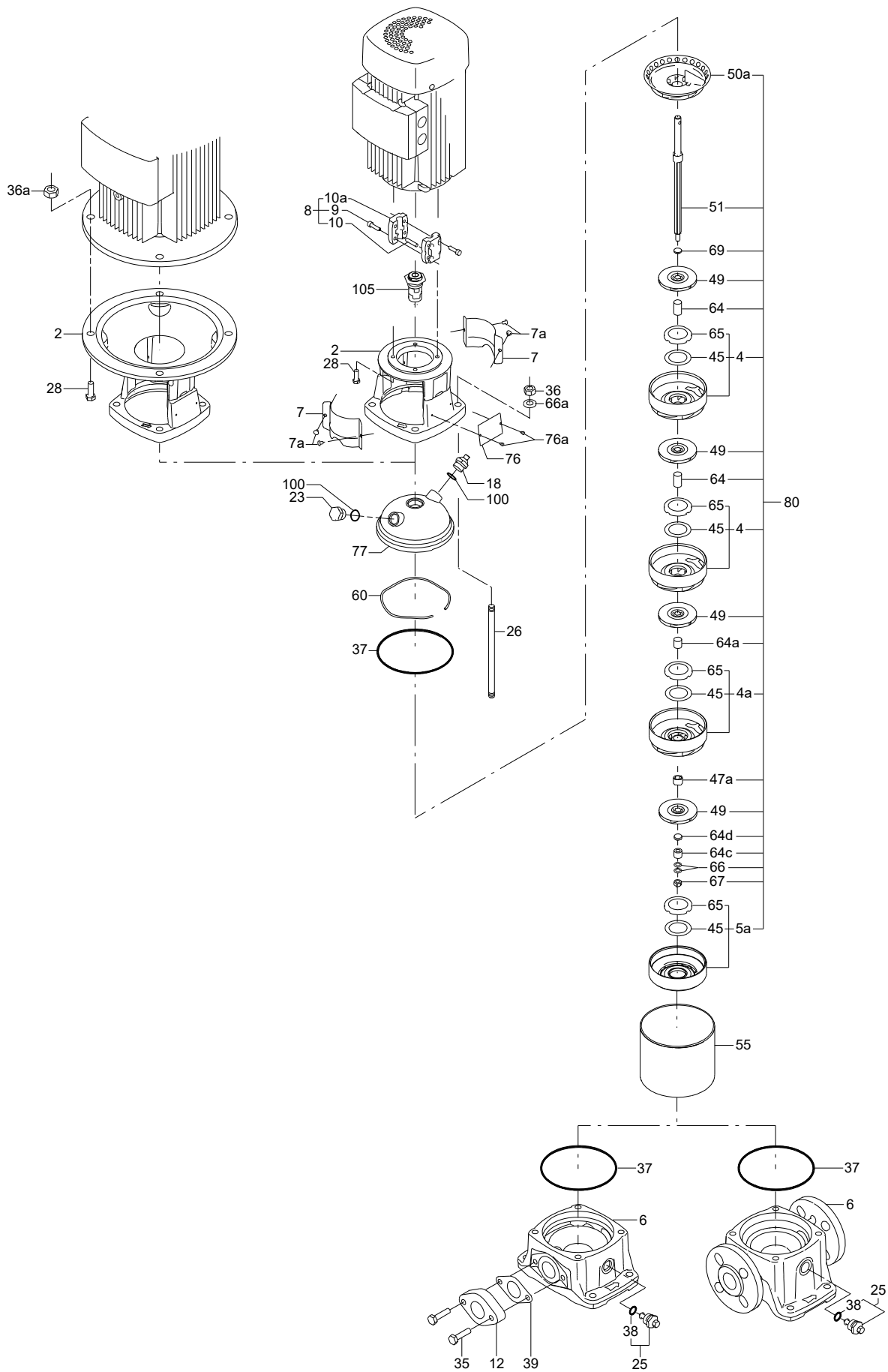

TM020216

**Chamber stack complete**

Pos.	Pump type	CR/CRI 5	CRN 5
	SiC/SiC bearings	Kit No	Kit No
	2	96453575	96453598
	3	96453576	96453599
	4	96453577	96453600
	5	96453578	96453601
	6	96453579	96453602
	7	96453580	96453603
	8	96453581	96453604
	9	96453582	96453605
	10	96453583	96453606
	11	96453584	96453607
	12	96453585	96453608
80	13	96453586	96453609
	14	96453587	96453610
	15	96453588	96453611
	16	96453589	96453612
	18	96453590	96453613
	20	96453591	96453614
	22	96453592	96453615
	24	96453593	96453616
	26	96453594	96453617
	29	96453595	96453618
	32	96453596	96453619
	36	96453597	96453620

**Coupling guard**

Description	Kit No
MG 71 - 80	96505130
MG 90 - 132	96505131
NEMA, F 182/213 TC	96505132

**Content**

Pos.	Description	Quantity
7	Coupling guard	2
7a	Screw	4

**Plug**

Description	Kit No
EPDM/FKM0	96505133
EPDM/FKM/NEMA	96511103

**Content**

Pos.	Description	Quantity	
18	Vent screw	1	
23a	Pipe plug	1	
23b	Pipe plug	1	
25	Drain plug with bypass valve	1	
38	O-ring 16.3 x 2.4	EPDM	1
		FKM	1
100	O-ring 16.3 x 2.4	EPDM	2
		FKM	2

CR 5

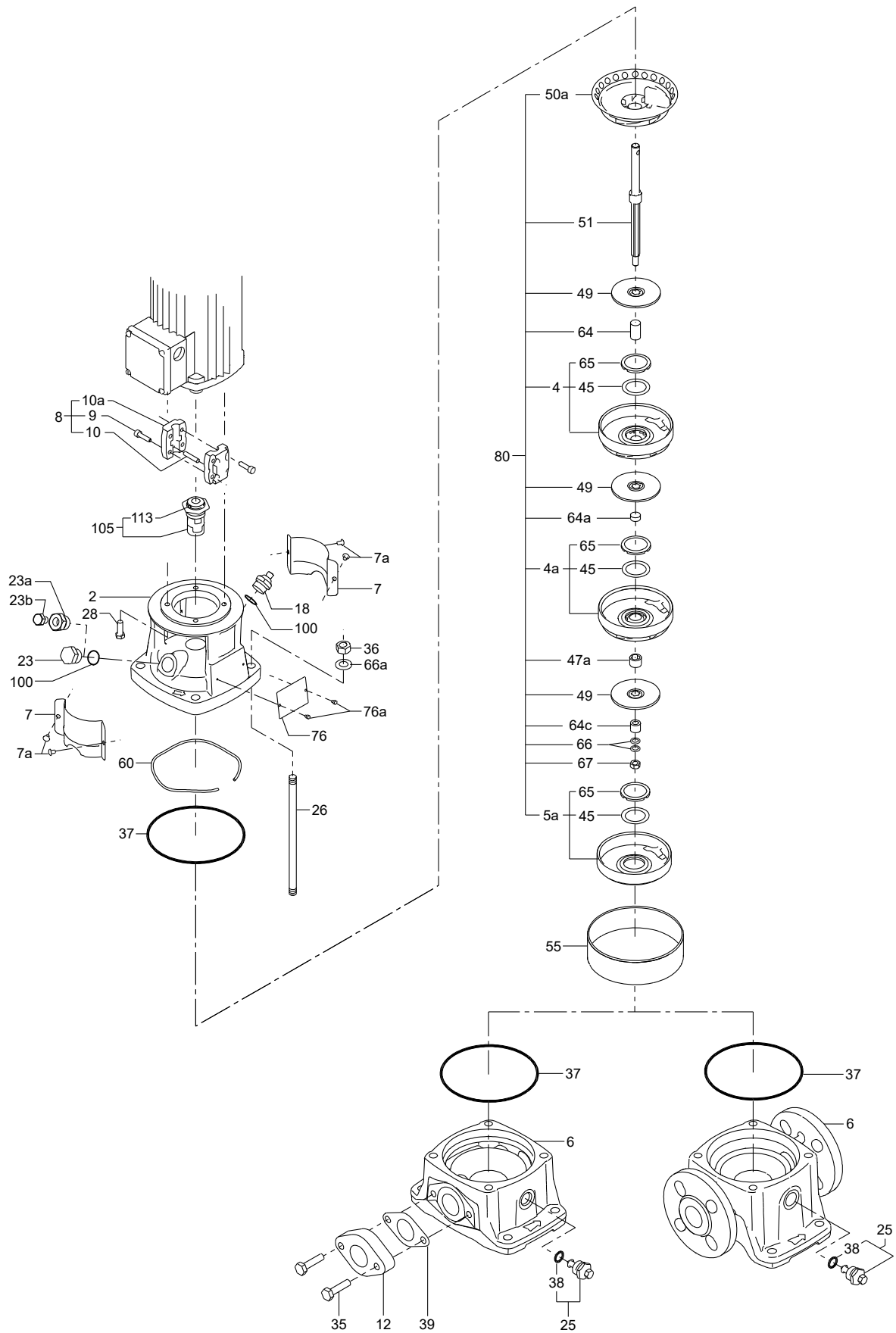

TM020210

CRI, CRN 5

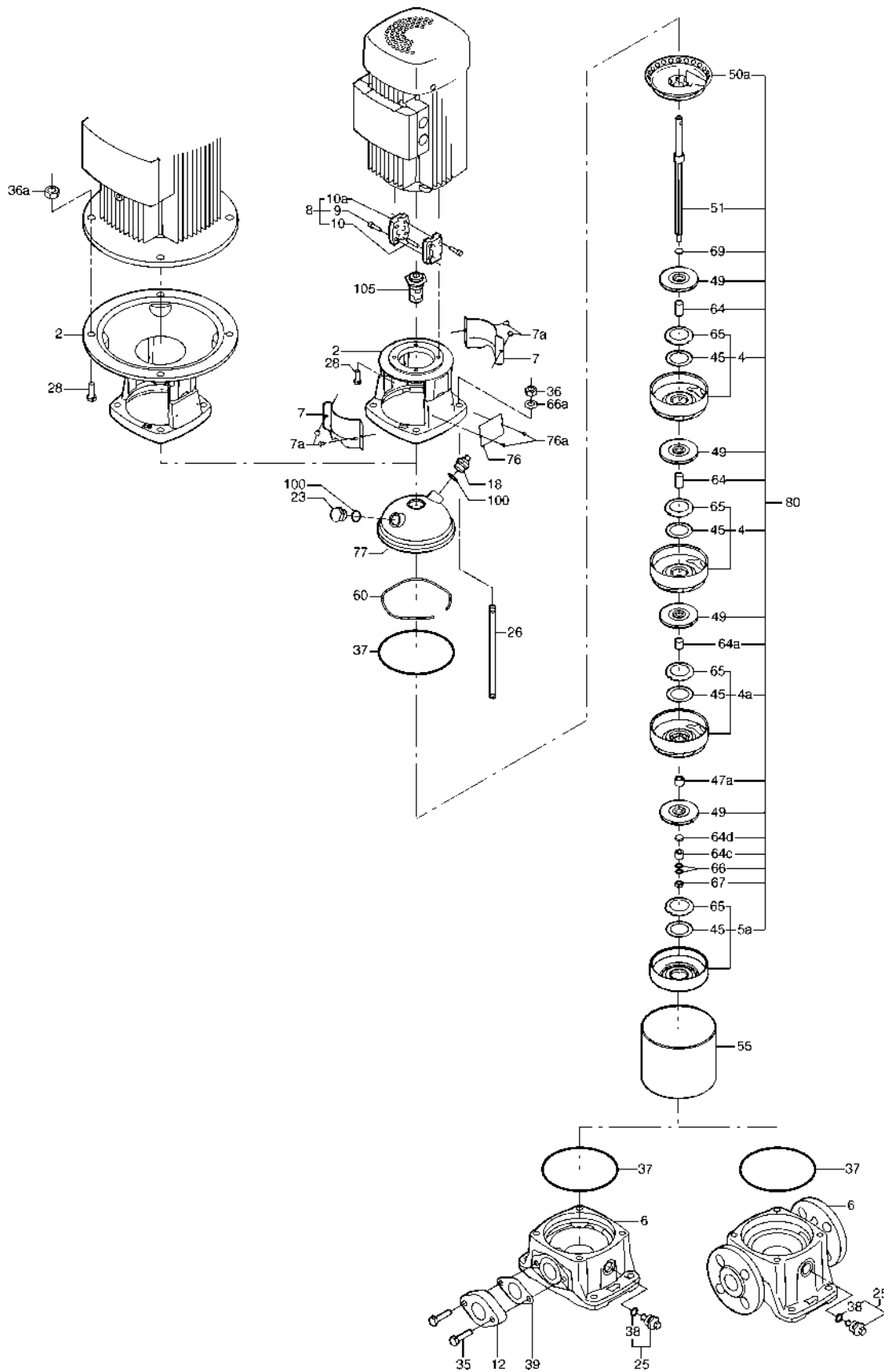

TM020216



**CR 8****50/60 Hz, models A, B****Chamber stack complete**

Number of stages	Consists of items: 3, 3a, 4, 4a, 44, 47a, 49, 51, 61, 64, 64a, 64c, 64d, 66, 67, 69	
	Kit No Ceramic bearings	Kit No Bronze bearings
1	425049	425267
2	425050	425268
3	425051	425269
4	425052	425270
5	425053	425271
6	425054	425272
8	425055	425273
10	425056	425274
12	425057	425275
14	425058	425276
16	425059	425277
18	425060	425278
20	425061	425279

**Coupling complete**

Motor/pump shaft diameter [mm]	Kit No
14/16	339114
19/16	339119
24/16	339124
28/16	339128
38/16	339138
42/16	339142
15.9/16, NEMA	425260
28.6/16, NEMA	425261
34.9/16, NEMA	425262
41.3/16, NEMA	425263

**Content**

Pos.	Description	Quantity
8	Coupling half	2
9	Screw	4
10	Pin	1

**Shaft seal**

Pos.	Kit No	985204	425085	985874	425062	425063	985838	985829	985828	985834	425763	425762
	Description	AUUE/V	AUUE/V	AUUE	BUBE	BUBV	RUUE/V	RUUK	AUUK	AUAK	BQQE	BQQV
37	Sleeve gasket	2	-	-	2	2	2	2	2	2	2	2
37	Vulcanised sleeve gasket	-	2	2	2	2	2	-	-	-	-	-
105	Shaft seal	1	1	1	1	1	1	1	1	1	1	1

**Wear parts**

Pos.	Kit No	425066	425067	425068	425300	425301	425302
		1-6	8-12	14-20	1-6	8-12	14-20
	Description	Ceramic bearings			Bronze bearings		
4a	Bearing chamber	1	2	3	1	2	3
37	Sleeve gasket	2	2	2	2	2	2
38	Drain plug gasket <sup>7)</sup>	1	1	1	1	1	1
39	Flange gasket	2	2	2	2	2	2
45	Neck ring	5	10	17	5	10	17
47a	Bearing ring	1	2	3	1	2	3
57	O-ring for drain plug <sup>7)</sup>	1	1	1	1	1	1
61	Spacer for shaft seal	1	1	1	1	1	1
62	Stop ring	1	1	1	1	1	1
64c	Spacer	1	1	1	1	1	1
65	Neck ring retainer	5	10	17	5	10	17
66	Spring washer	1	1	1	1	1	1
67	Lock nut	1	1	1	1	1	1
100	O-ring	1	1	1	1	1	1

7) EPDM and FKM

CR 8

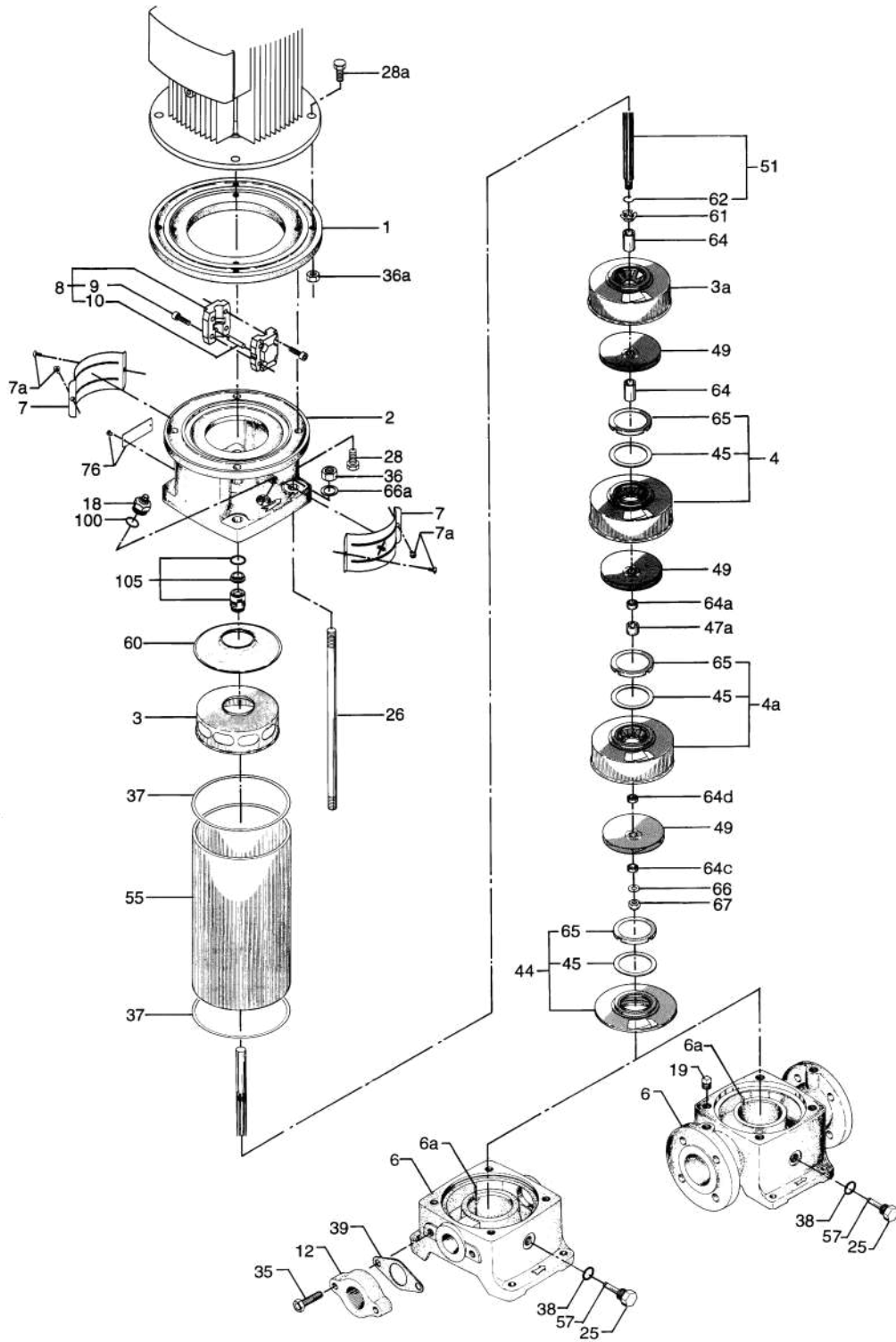

TM002340

## CR, CRI, CRN 10

### 50/60 Hz

#### Chamber stack complete (silicon-carbide bearing)

Pos.	Pump type	CR	CRI	CRN
	Number of stages	Kit No	Kit No	Kit No
80	1	96508403	96491694	96491720
	2	96508404	96491695	96491721
	3	96508405	96491696	96491722
	4	96508406	96491697	96491723
	5	96508407	96491698	96491724
	6	96508408	96491699	96491725
	7	96508409	96491700	96491726
	8	96508410	96491701	96491727
	9	96508411	96491702	96491728
	10	96508412	96491703	96491729
	12	96508413	96491704	96491730
	14	96508414	96491705	96491731
	16	96508415	96491706	96491732
	17	96529403	96529404	96529405
18	96508416	96491707	96491733	
20	96508417	96491708	96491734	
22	96508418	96491709	96491735	

#### Coupling guard

Description	Kit No
MG 71 - 80	96509611
MG 90 - 100, 56C	96509612
MG 132, 182TC - 215TC	96509613
MG 132, 182TC - 215TC	96509614

#### Wear parts

Pos.	Bearings	Kit No		
		Silicon carbide	Bronze	Carbon graphite
		96511889	96511920	96511921
		96511920	96511923	96511926
		96511921	96511924	96511927
	Description/stages	-8	-14	-22
4a	Chamber with bearing	1	2	3
26b	Screw5	2	2	2
26c	Washer	2	2	2
45	Neck ring	7	12	19
47a	Bearing ring, rotating	1	2	3
61	Seal driver	1	1	1
62	Stop ring	1	1	1
64a	Spacing pipe	1	2	3
64c	Spacer lower	1	1	1
64d	Spacing pipe	1	2	3
65	Neck ring retainer	7	12	19
66	Lock washer	1	1	1
67	Lock nut	1	1	1

#### Content

Pos.	Description	Quantity
7	Coupling guard	2
7a	Screw	4

#### Shaft seal

Description	Kit No
HQQE	96511844
HQQV	96511845
HQQK	96511846
HQQF	96511847
HQBE	96511848
HQBV	96511849
HUBE	96511836
HUBV	96511837
HUBK	96511838
HUBF	96511839
HUUE	96511840
HUUV	96511841
HUUK	96511842
HUUF	96511843

#### Content

Pos.	Description	Quantity
105	Shaft seal	1
	Adjusting fork	1

CRI, CRN 10

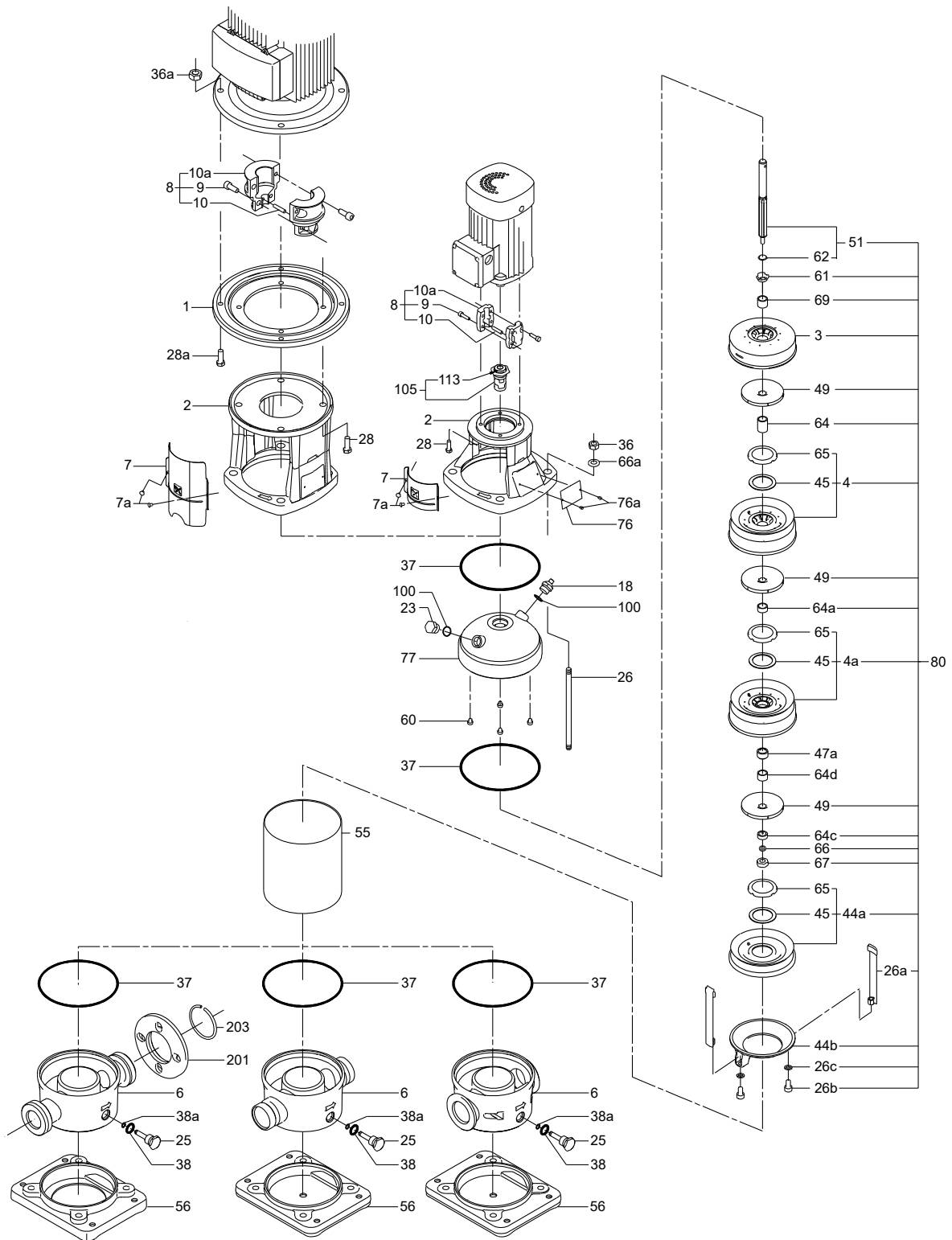

TM026495

CR 10

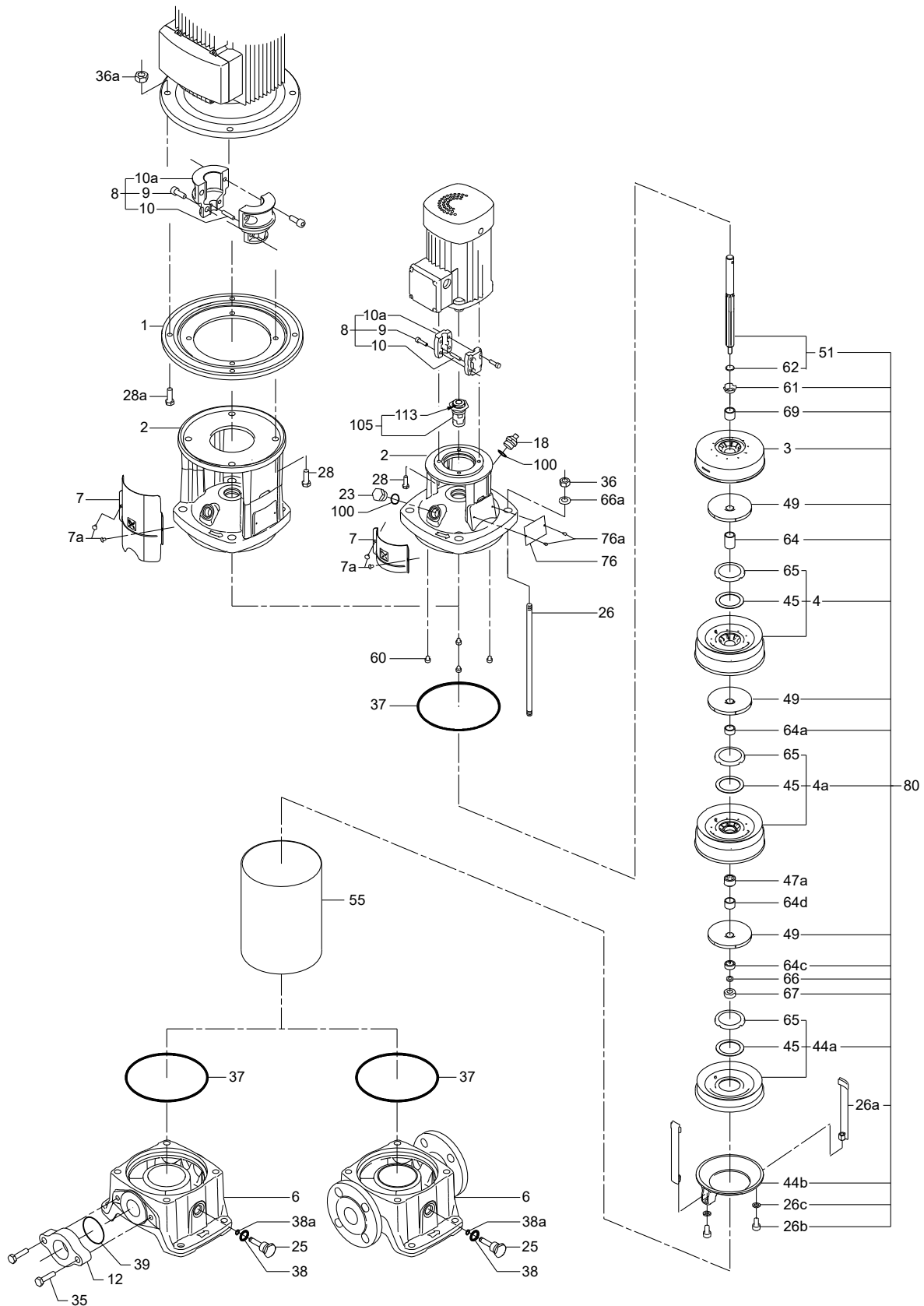

TM026496

**Coupling complete**

Motor/pump shaft diameter [mm]	Kit No
14/16	<a href="#">96511315</a>
19/16	<a href="#">96511317</a>
24/16	<a href="#">96511319</a>
28/16	<a href="#">96511350</a>
38/16	<a href="#">96511351</a>
15.9/16, NEMA	<a href="#">96511353</a>
28.6/16, NEMA	<a href="#">96511354</a>
34.9/16, NEMA	<a href="#">96511355</a>
41.3/16, NEMA	<a href="#">96511356</a>

**Content**

Pos.	Description	Quantity
9	Screw	4
8	10 Pin	1
10a	Coupling half	2

**Plug**

Pos.	Description	CR	CRI, CRN	CR NEMA	CRI, CRN NEMA
	Kit No	<a href="#">96511311</a>	<a href="#">96511312</a>	<a href="#">96511313</a>	<a href="#">96511314</a>
18	Vent screw	1	1	1	1
23	Pipe plug	1	1	1	1
23a	Pipe plug 1/4"	-	-	1	1
25	Drain plug	1	1	1	1

Pos.	Description	CR	CRI, CRN	CR NEMA	CRI, CRN NEMA
	Kit No	<a href="#">96511311</a>	<a href="#">96511312</a>	<a href="#">96511313</a>	<a href="#">96511314</a>
38	O-ring 16.3x2.4 EPDM + FKM	1 + 1	1 + 1	1 + 1	1 + 1
38a	O-ring 5.3x2.4 EPDM + FKM	1 + 1	1 + 1	1 + 1	1 + 1
100	O-ring 16.3x2. EPDM + FKM	2 + 2	2 + 2	2 + 2	2 + 2

**O-ring**

Description	Kit No
EPDM	<a href="#">96509609</a>
FKM	<a href="#">96509610</a>

**Content**

Pos.	Description	Quantity
37	O-ring 170.7 x 3.3	2
38	O-ring 16.3 x 2.4	1
38a	O-ring 5.3 x 2.4	1
	Gasket, oval flange, CR 10	2
	O-ring, oval flange, CR 15, 20	2
39	Gasket, FGJ flange, CR 10	2
	Gasket, FGJ flange, CR 15, 20	2
60	Rubber spring	4
100	O-ring	2

CRI, CRN 10

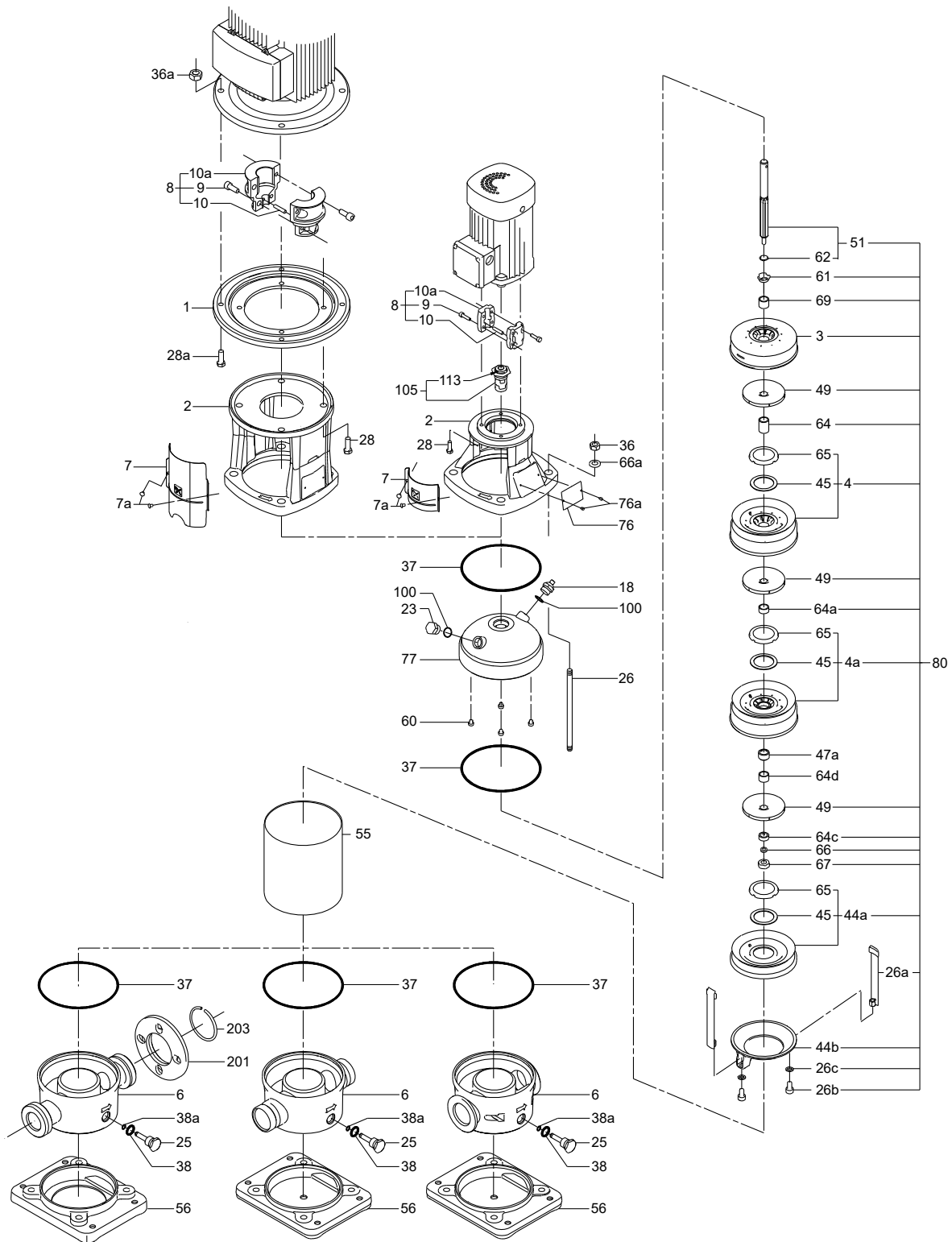

TM026495

CR 10

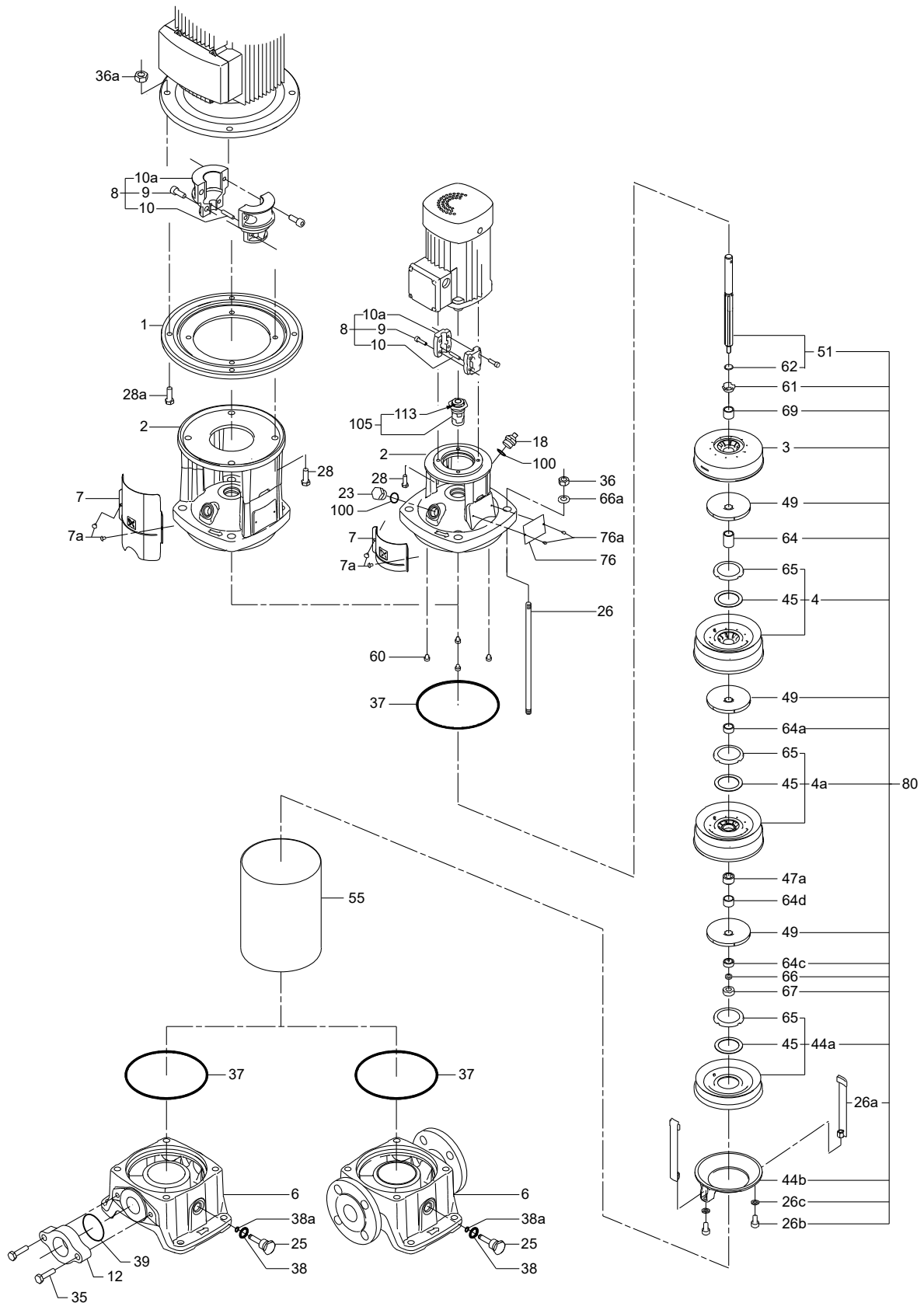

TM026496



## CR, CRI, CRN 15 50/60 Hz

### Coupling guard

Description	Kit No
MG 71 - 80	96509611
MG 90 - 100, 56C	96509612
MG 132, 182TC - 215TC	96509613
MG 132, 182TC - 215TC	96509614

### Content

Pos.	Description	Quantity
7	Coupling guard	2
7a	Screw	4

### Plug

Pos.	Description	CR	CRI, CRN	CR		CRI, CRN	
				NEMA	NEMA	NEMA	NEMA
	Kit No	96511311	96511312	96511313	96511314		
18	Vent screw	1	1	1	1		
23	Pipe plug	1	1	1	1		
23a	Pipe plug	-	-	1	1		
25	Drain plug	1	1	1	1		
38	O-ring 16.3 x 2.4, EPDM + FKM	1 + 1	1 + 1	1 + 1	1 + 1		
	O-ring 5.3 x 2.4, EPDM + FKM	1 + 1	1 + 1	1 + 1	1 + 1		
38a	O-ring 5.3 x 2.4, EPDM + FKM	1 + 1	1 + 1	1 + 1	1 + 1		
100	O-ring 6.3 x 2.4, EPDM + FKM	2 + 2	2 + 2	2 + 2	2 + 2		

### Wear parts

Pos.	Description/stages	Kit No		
		-6	-10	-17
	<b>Bearings</b>			
	<b>Silicon carbide</b>	96511824	96511827	96511830
	<b>Bronze</b>	96511825	96511828	96511831
	<b>Carbon graphite</b>	96511826	96511829	96511832
4a	Chamber with bearing	1	2	3
26b	Screw	2	2	2
26c	Washer	2	2	2
45	Neck ring	5	8	14
47a	Bearing ring, rotating	1	2	3
49c	Impeller wear ring	6	10	17
61	Seal driver	1	1	1
62	Stop ring	1	1	1
64a	Spacing pipe 17.0 mm	1	2	3
64b	Spacing pipe 5.0 mm	1	1	1
64c	Spacer lower	1	1	1
64d	Spacing pipe 12.6 mm	1	2	3
65	Neck ring retainer	5	8	14
66	Lock washer	1	1	1
67	Lock nut	1	1	1

### Shaft seal

Description	Kit No
HQQE	96511844
HQQV	96511845
HQQK	96511846
HQQF	96511847
HQBE	96511848
HQBV	96511849
HUBE	96511836
HUBV	96511837
HUBK	96511838
HUBF	96511839
HUUE	96511840
HUUV	96511841
HUUK	96511842
HUUF	96511843

### Content

Pos.	Description	Quantity
105	Shaft seal	1
	Adjusting fork	1

CRI, CRN 15

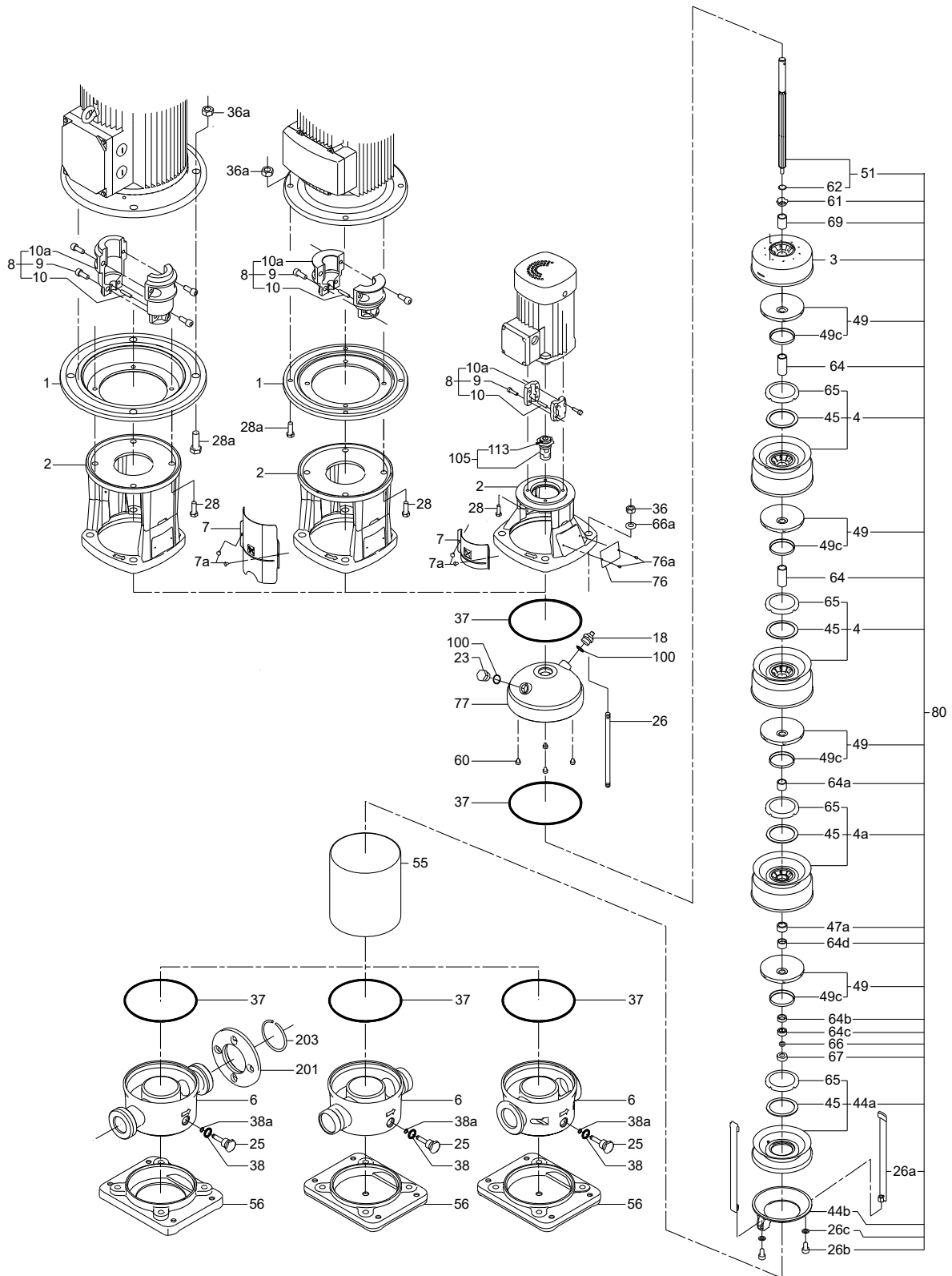

TM026498

CR 15

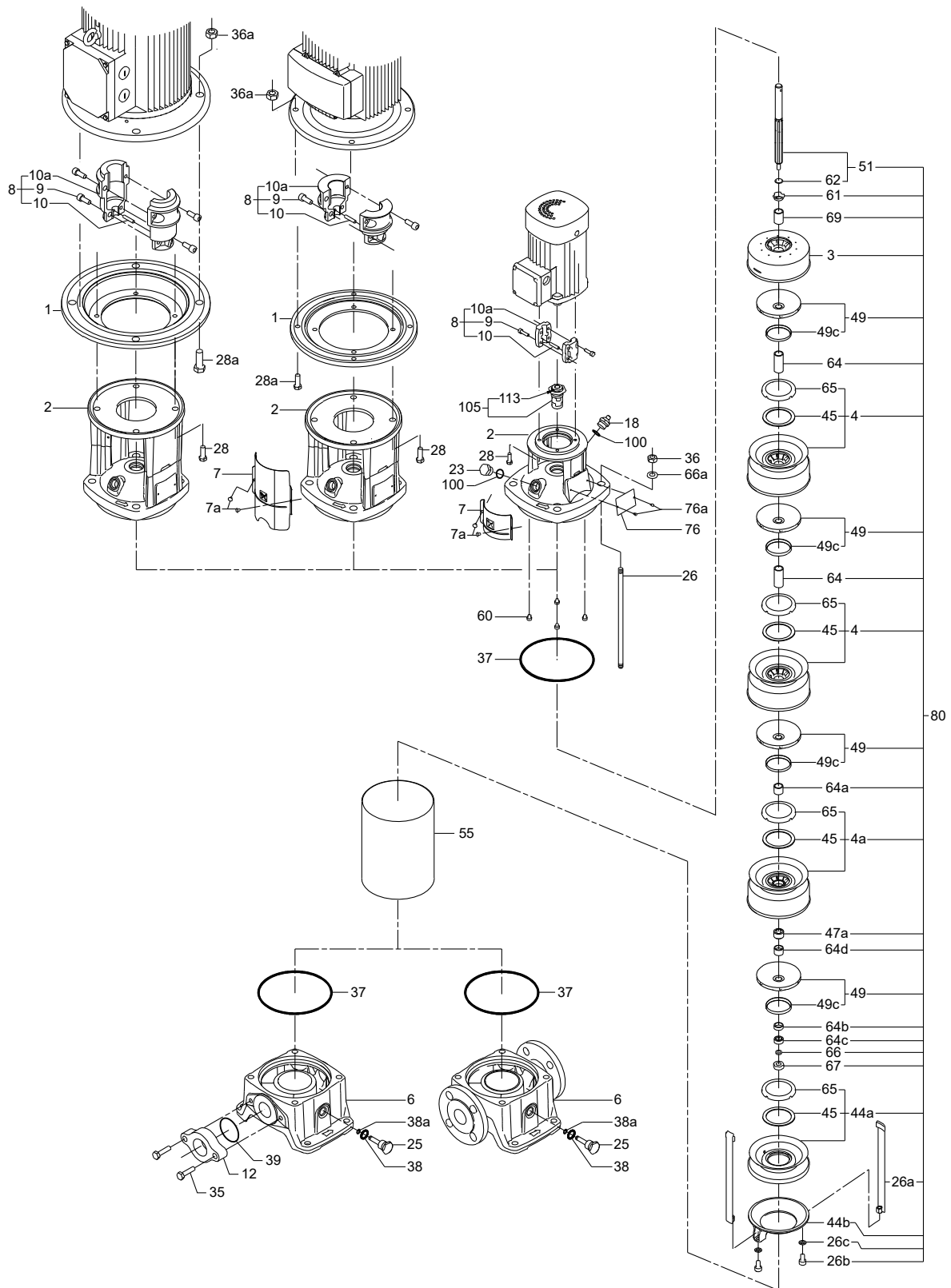

TM026497

**Chamber stack complete (silicon-carbide bearing)**

Pos.	Pump type	CR	CRI	CRN
	Number of stages	Kit No	Kit No	Kit No
80	1	96508453	96491736	96491749
	2	96508454	96491737	96491760
	3	96508455	96491738	96491761
	4	96508456	96491739	96491762
	5	96508457	96491740	96491763
	6	96508458	96491741	96491764
	7	96508459	96491742	96491765
	8	96508490	96491743	96491766
	9	96508491	96491744	96491767
	10	96508492	96491745	96491768
	12	96508493	96491746	96491769
	14	96508494	96491747	96491770
	17	96508495	96491748	96491771

**Coupling complete**

Motor/pump shaft diameter [mm]	Kit No
14/16	96511315
19/16	96511317
24/16	96511319
28/16	96511350
38/16	96511351
42/16	96511352
15.9/16, NEMA	96511353

Motor/pump shaft diameter [mm]	Kit No
28.6/16, NEMA	96511354
34.9/16, NEMA	96511355
41.3/16, NEMA	96511356

**Content**

Pos.	Description	Quantity
8	9 Screw	4
	10 Pin	1
	10a Coupling half	2

**O-ring**

Description	Kit No
EPDM	96509609
FKM	96509610
FFKM	96533374

**Content**

Pos.	Description	EPDM
37	O-ring	2
38	O-ring	1
38a	O-ring	1
	Gasket, oval flange, CR 10	2
39	O-ring 90 x 3, oval flange, CR 15, 20	2
	Gasket, FGJ flange, CR 10	2
60	Rubber spring	4
100	O-ring	2

CRI, CRN 15

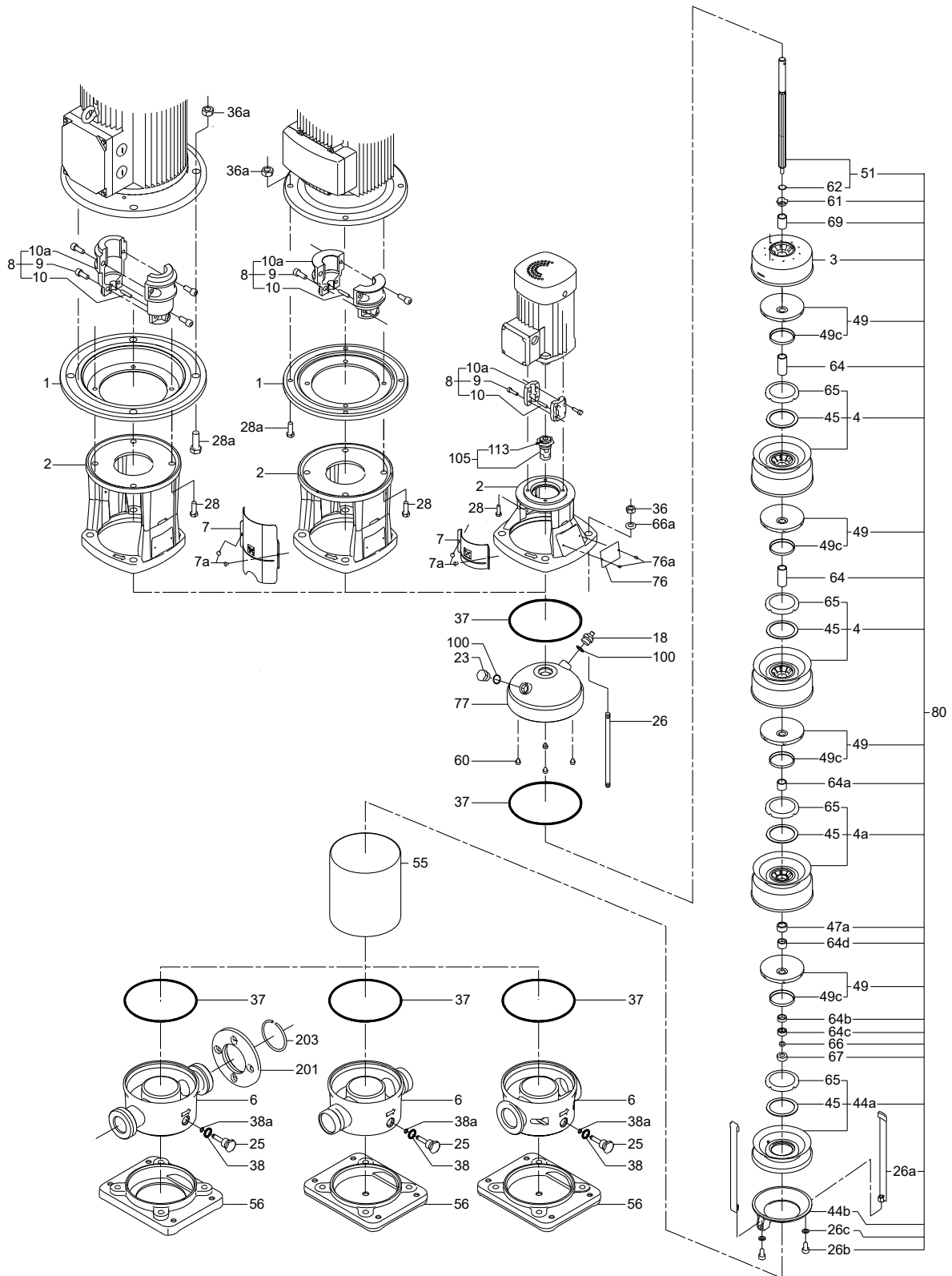

TM026498

CR 15

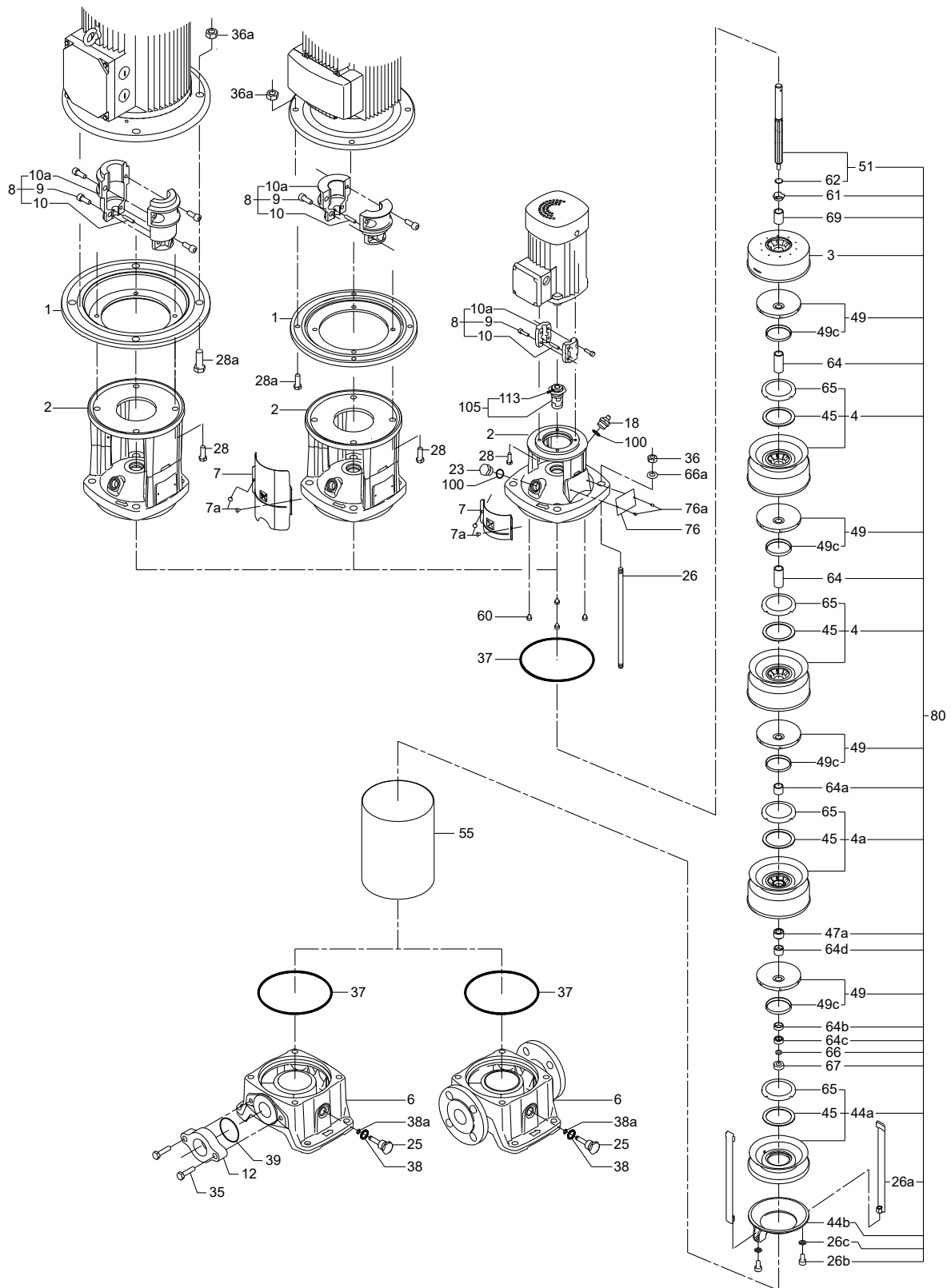

TM026497

**CR 16****50/60 Hz, models A, B****Chamber stack complete**

Consists of items: 3a, 4, 4a, 44, 47a, 49, 51, 61, 64, 64a, 64c, 64d, 66, 69		Kit No	Kit No
Number of stages	Ceramic bearings	Bronze bearings	
2	335065	335190	
3	335066	335191	
4	335067	335192	
5	335068	335193	
6	335069	335194	
7	335070	335195	
8	335071	335196	
10	335072	335197	
12	335073	335198	
14	335074	335199	
16	335075	335200	

**Shaft seal**

Pos.	Description	AUUE/V	AUUE/V	AUUE	BUBE	BUBV	RUUE/V	RUUK	AUUK	AUAK	BQQE	BQQV
	Kit No	985204	425085	985874	425062	425063	985838	985829	985828	985834	425763	425762
37	Sleeve gasket	2	-	-	2	2	2	2	2	2	2	2
37	Vulcanised sleeve gaskets (NBR)	-	2	-	-	-	-	-	-	-	-	-
37	Vulcanised sleeve gaskets (EPDM)	-	-	2	-	-	-	-	-	-	-	-
105	Shaft seal	1	1	1	1	1	1	1	1	1	1	1

**Wear parts**

Pos.	Description	Number of stages	2-6	7-10	12-16	2-6	7-10	12-16
			Ceramic bearings			Bronze bearings		
	Kit No		335078	335079	335080	335300	335301	335302
4a	Bearing chamber		1	2	3	1	2	3
37	Sleeve gasket		2	2	2	2	2	2
38	Drain plug gasket <sup>8)</sup>		1	1	1	1	1	1
39	Flange gasket		2	2	2	2	2	2
45	Neck ring		5	8	13	5	8	13
47a	Bearing ring		1	2	3	1	2	3
49c	Wear ring		6	10	16	6	10	16
57	O-ring for drain plug <sup>8)</sup>		1	1	1	1	1	1
61	Spacer for shaft seal		1	1	1	1	1	1
62	Stop ring		1	1	1	1	1	1
64c	Spacer		1	1	1	1	1	1
65	Neck ring retainer		5	8	13	5	8	13
66	Spring washer		1	1	1	1	1	1
67	Lock nut		1	1	1	1	1	1
100	O-ring <sup>8)</sup>		1	1	1	1	1	1

<sup>8)</sup> EPDM and FKM

**Coupling complete**

Motor/pump shaft diameter [mm]	Kit No
24/16	339124
28/16	339128
38/16	339138
42/16	339142
28.6/16	425261
34.9/16, NEMA	425262
41.3/16, NEMA	425263

**Content**

Pos.	Quantity
Coupling half	2
9 Screw	4
10 Pin	1

CR 16

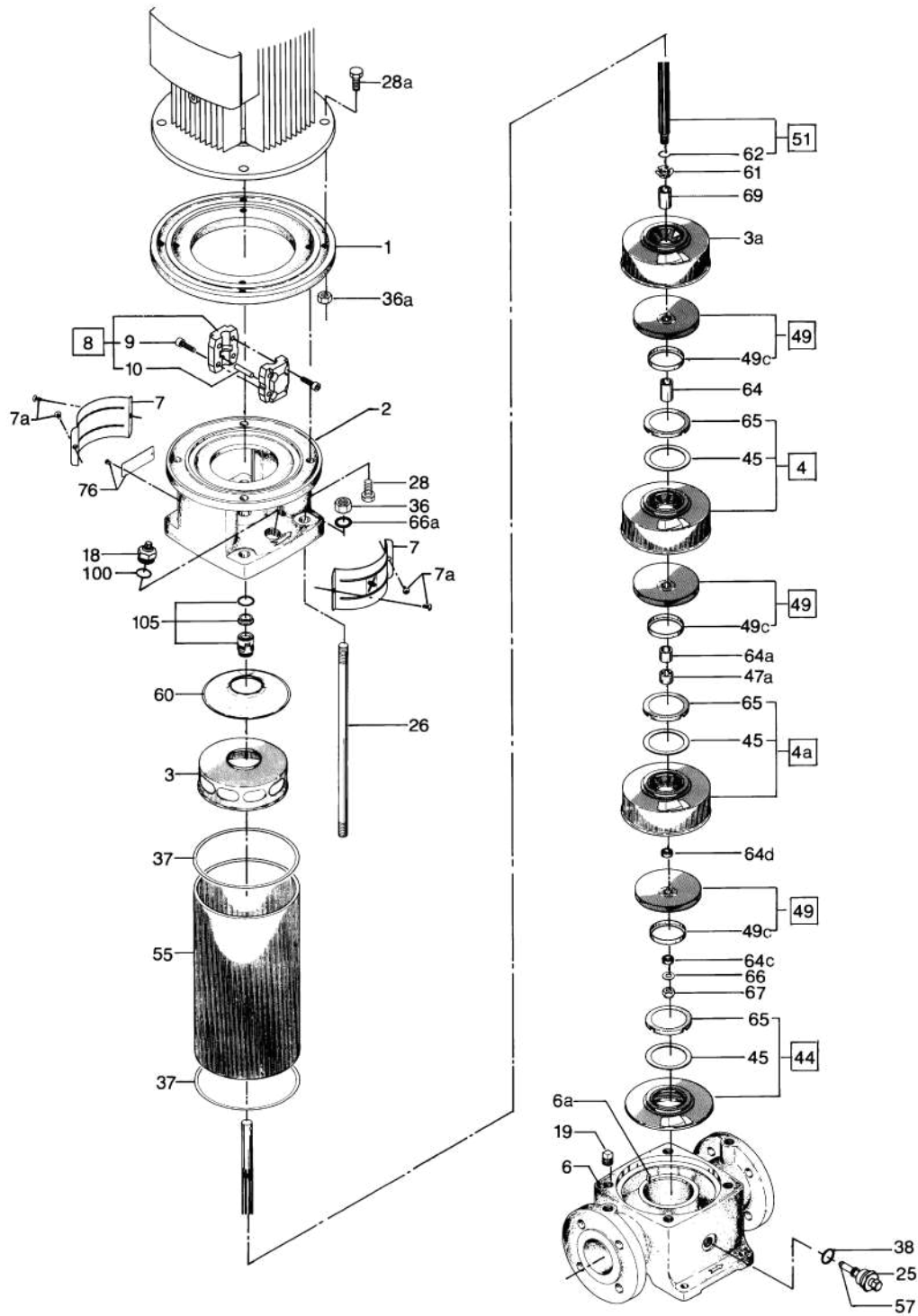

TM002360



## CR, CRI, CRN 20 50/60 Hz

### Coupling guard

Description	Kit No
MG 71 - 80	96509611
MG 90 - 100, 56C	96509612
MG 132, 182TC - 215TC	96509613
MG 132, 182TC - 215TC	96509614

### Content

Pos.	Description	Quantity
7	Coupling guard	2
7a	Screw	4

### Plug

Pos.	Description	CR	CRI, CRN	CR	CRI, CRN
				NEMA	NEMA
	Kit No	96511311	96511312	96511313	96511314
18	Vent screw	1	1	1	1
23	Pipe plug	1	1	1	1
23a	Pipe plug 1/4"	-	-	1	1
25	Drain plug	1	1	1	1
38	O-ring EPDM + FKM	1 + 1	1 + 1	1 + 1	1 + 1
38a	O-ring EPDM + FKM	1 + 1	1 + 1	1 + 1	1 + 1
100	O-ring EPDM + FKM	2 + 2	2 + 2	2 + 2	2 + 2

### Shaft seal

Description	Kit No
HQQE	96511844
HQQV	96511845
HQQK	96511846
HQQF	96511847
HQBE	96511848
HQBV	96511849
HUBE	96511836
HUBV	96511837

Description	Kit No
HUBK	96511838
HUBF	96511839
HUUE	96511840
HUUV	96511841
HUUK	96511842
HUUF	96511843

### Content

Pos.	Description	Quantity
105	Shaft seal	1
	Adjusting fork	1

### Wear parts

Pos.	Description/stages	Kit No		
		-6	-10	-17
	<b>Bearings</b>			
	Silicon carbide	96511824	96511827	96511830
	Bronze	96511825	96511828	96511831
	Carbon graphite	96511826	96511829	96511832
4a	Chamber with bearing	1	2	3
26b	Screw	2	2	2
26c	Washer	2	2	2
45	Neck ring	5	8	14
47a	Bearing ring rotating	1	2	3
49c	Impeller wear ring	6	10	17
61	Seal driver	1	1	1
62	Stop ring	1	1	1
64a	Spacing pipe	1	2	3
64b	Spacing pipe	1	1	1
64c	Spacer lower	1	1	1
64d	Spacing pipe	1	2	3
65	Neck ring retainer	5	8	14
66	Lock washer	1	1	1
67	Lock nut	1	1	1

CRI, CRN 20

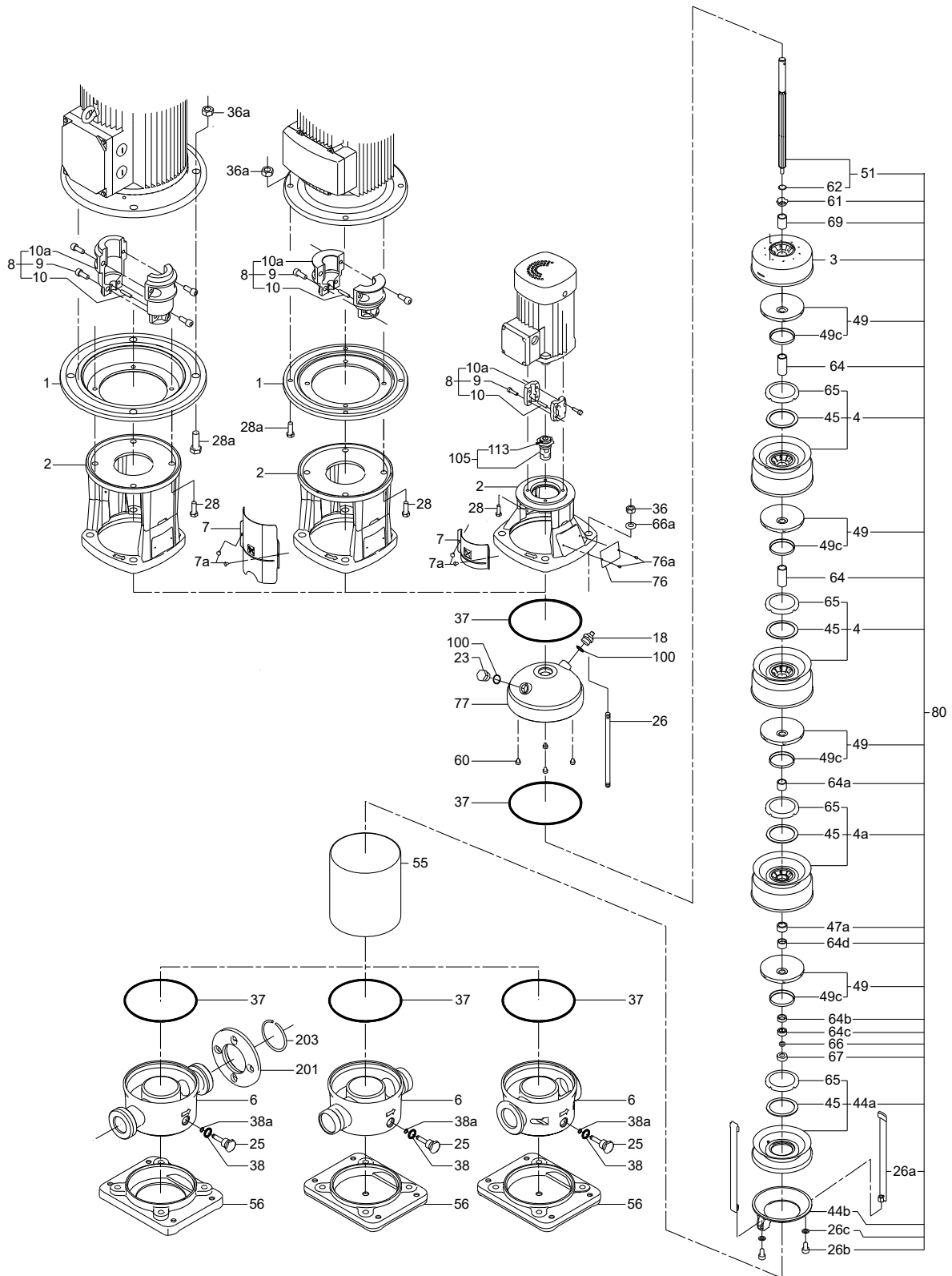

TM026498

CR 20

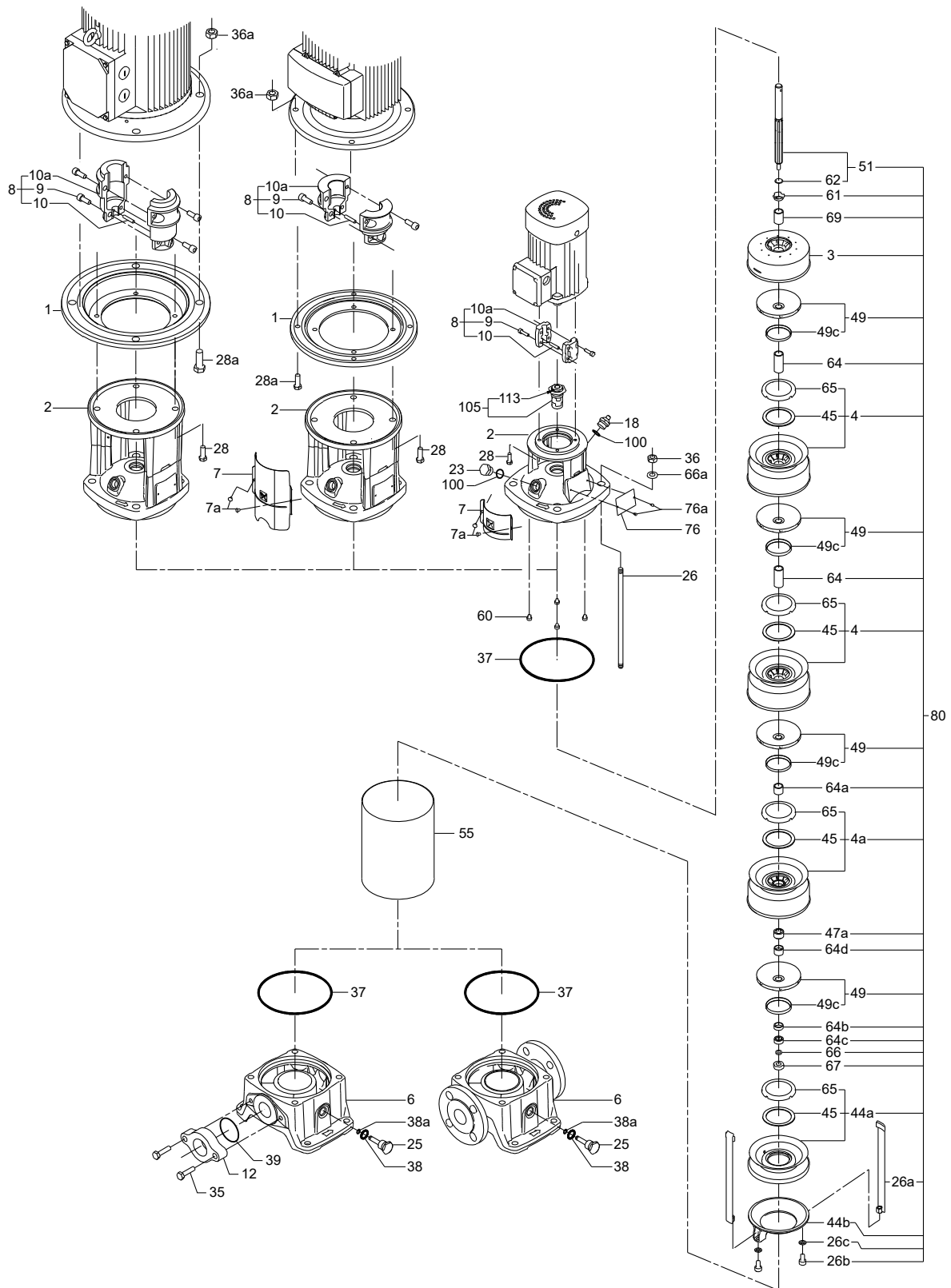

TM026497

**Chamber stack complete (silicon-carbide bearing)**

Pos.	Pump type	CR	CRI	CRN
	Number of stages	Kit No	Kit No	Kit No
80	1	96508541	96491772	96491784
	2	96508542	96491773	96491785
	3	96508543	96491774	96491786
	4	96508544	96491775	96491787
	5	96508545	96491776	96491788
	6	96508546	96491777	96491789
	7	96508547	96491778	96491790
	8	96508548	96491779	96491791
	10	96508550	96491780	96491792
	12	96508551	96491781	96491793
	14	96508552	96491782	96491794
	17	96508553	96491783	96491795

**Coupling complete**

Pos.	Kit No		96511315	96511317	96511319	96511350	96511351
	Motor/pump shaft diameter [mm]		14/16	19/16	24/16	28/16	38/16
Description							
8	9	Screw	4	4	4	4	4
	10	Pin	1	1	1	1	1
	10a	Coupling half	2	2	2	2	2

Pos.	Kit No		96511352	96511353	96511354	96511355	96511356
	Motor/pump shaft diameter [mm]		42/16	15.9/16	28.6/16	34.9/16	41.3/16
Description			NEMA	NEMA	NEMA	NEMA	NEMA
8	9	Screw		4	4	4	4
	10	Pin	1	1	1	1	1
	10a	Coupling half	2	2	2	2	2

**Seal kit**

Pos.	Description	EPDM	FKM
	Kit No	96509609	96509610
37	O-ring	2	2
38	O-ring	1	1
38a	O-ring	1	1
39	Gasket, oval flange, CR 10	2	2
	O-ring 90 x 3, oval flange, CR 15/20	2	2
	Gasket, FGJ flange, CR 10	2	2
	Gasket, FGJ flange, CR 15/20	2	2
60	Rubber spring	4	4
100	O-ring	2	2

CRI, CRN 20

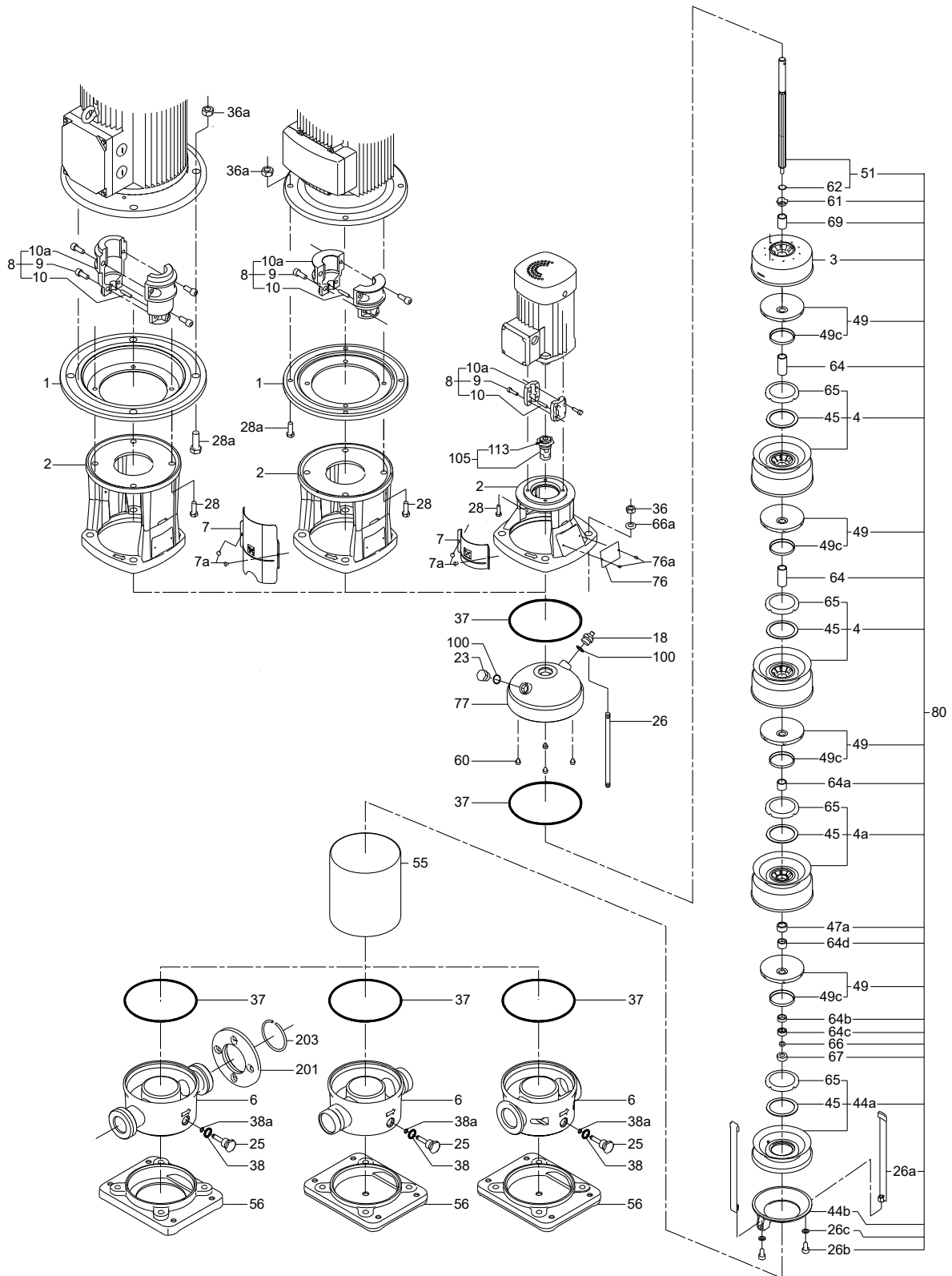

TM026498

CR 20

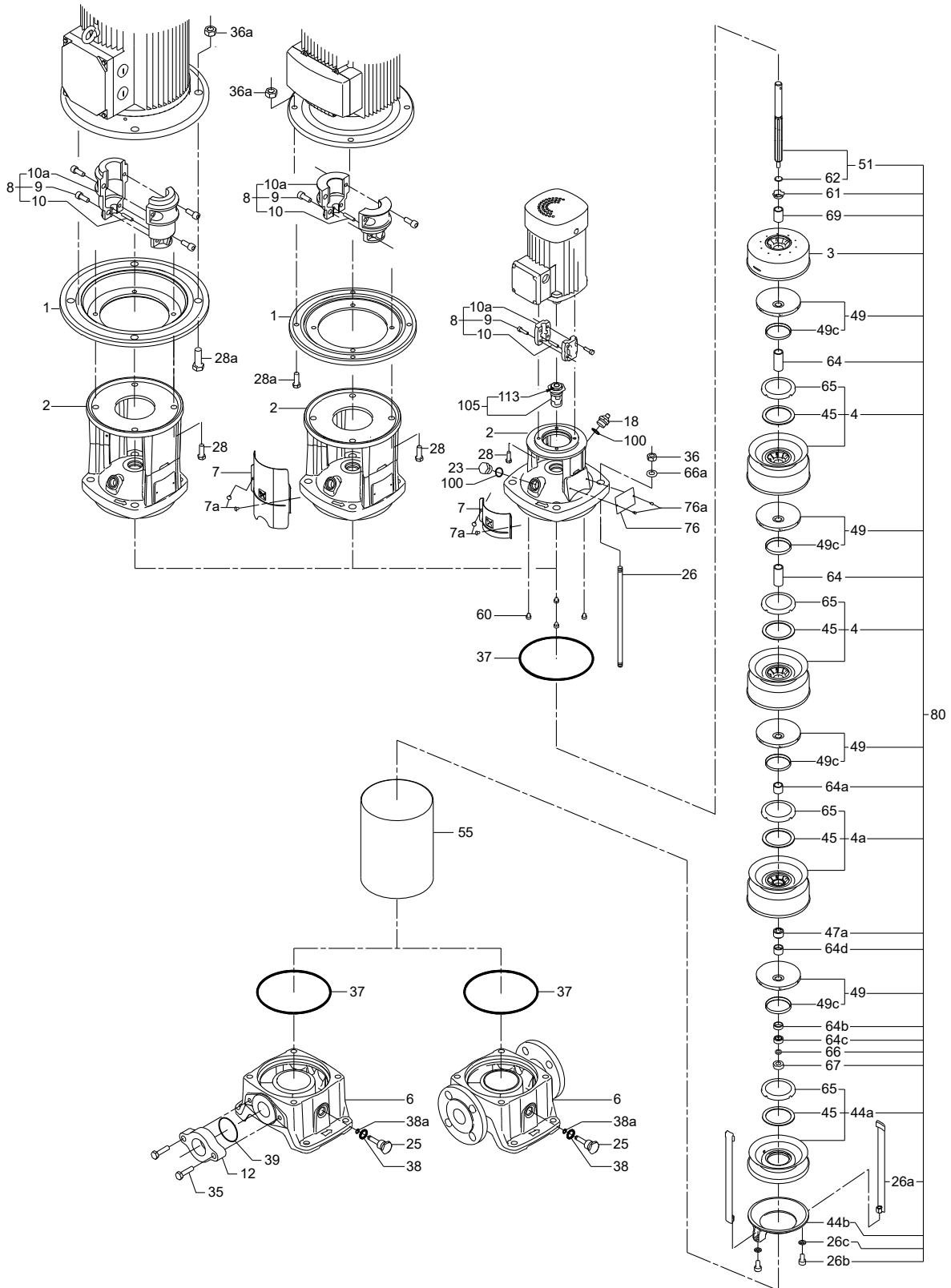

TM026497

## CR, CRN 32

### 50/60 Hz

#### Bearing

Pos.	Kit No	96416574	96416576
	Description	3-7	8-14
47a	Bearing	1	2
-	Adjusting fork	1	1

#### Bottom bearing

Pos.	Kit No	96416580
	Description	1-14
6g	Bearing ring (stationary)	1
31	Hexagon socket head screw	1
32	Washer	1
47b	Bearing ring (rotating)	1
66	Washer	1
66b	Lock washer	1
67	Hexagon socket head screw	1
D + E	Puller complete	1

#### O-ring

Description	Kit No
EPDM	96416597
FKM	96416598

#### Content

Pos.	Description	Quantity
37	O-ring	2
38	O-ring	4
60	Spring (rubber)	4

#### Wear parts

Pos.	Kit No	96416728	96416729	96416730	96416731
	Description	1-2	3-7	8-11	12-14
45	Neck ring	2	7	11	14
47	Bearing (carbon-filled PTFE)	-	1	2	2
47	Bearing (bronze)	-	1	2	2
47c	Sleeve	2	6	9	11
47d	Lock ring	2	7	11	14
49c	Wear ring	2	7	11	14
65	Seal carrier	2	7	11	14
-	Adjusting fork	1	1	1	1

Pos.	Description	Quantity
100	O-ring	2
109	O-ring	1
110	O-ring	1
-	Adjusting fork (shaft seal)	1

#### Shaft seal

Description	Kit No
HQQE	96525458
HQQV	96525490
HQQK	96533369
HQQF	96533412
HQBE	96525457
HQBV	96525459
HUBK	96533365
HUBF	96533366
HUUE	96436727
HUUV	96436728
HUUK	96533367
HUUF	96533368

#### Content

Pos.	Description	Quantity
105	Shaft seal	1

CR, CRN 32

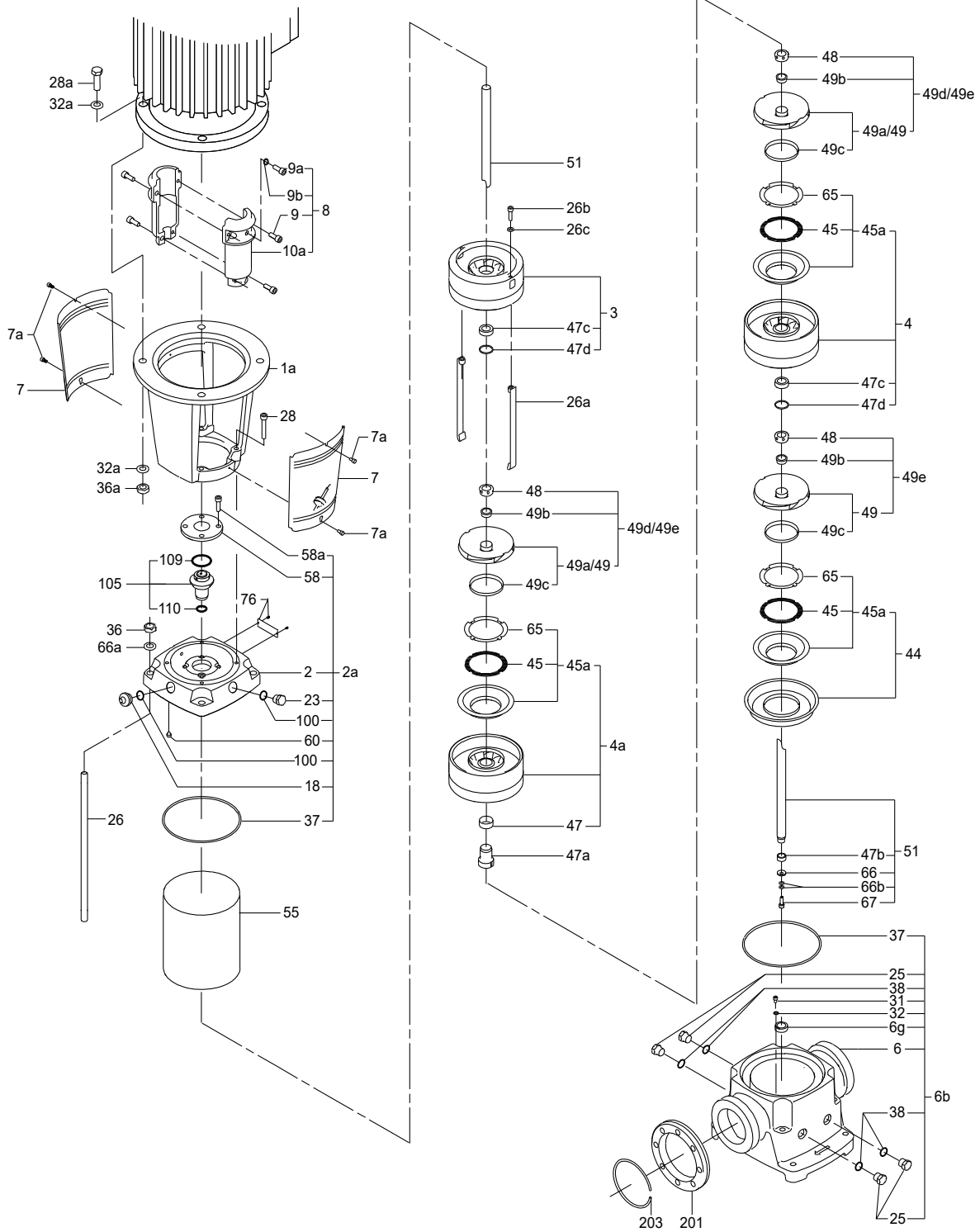

TM022299



**Coupling complete**

Pos.	Kit No	96416589	96416590	96416591	96416592	96416593	96416594	96475477	96475478
	Motor/pump shaft diameter [mm]	24/22	28/22	38/22	42/22	48/22	55/22	42/22	48/22
Description		For shafts with key and keyway							
10a	Coupling half	2	2	2	2	2	2	2	2
9	Hexagon socket head screw	4	4	4	4	4	4	4	4
9a	Hexagon socket head screw	-	-	-	-	-	-	1	1
9b	Washer	-	-	-	-	-	-	1	1
	Adjusting fork	1	1	1	1	1	1	1	1

**Coupling complete NEMA**

Motor/pump shaft diameter	Kit No
28.6/22	96417000
34.9/22	96417001
41.2/22	96417004
47.6/22	96417020

**Content**

Pos.	Description	Quantity
10a	Coupling half	2
9	Hexagon socket head screw	4
-	Adjusting fork	1

**Coupling guard**

Pos.	Kit No	96505134	96505135
	Description	MG 90 - MG 132	MG 160 - MG 225
7	Coupling guard	2	2
7a	Screw	4	4

**Chamber stack complete**

Pump type	CRN 32	CR 32
32-1-1	96416290	96416273
32-1	96416291	96416274
32-2-2	96416918	96416905
32-2-1	96416292	96416275
32-2	96416293	96416276
32-3-2	96416919	96416906
32-3	96416294	96416277
32-4-2	96416920	96416907
32-4	96416295	96416278
32-5-2	96416921	96416908
32-5	96416296	96416279
32-6-2	96416922	96416909
32-6	96416297	96416280
32-7-2	96416923	96416910
32-7	96416298	96416281
32-8-2	96416924	96416911
32-8	96416299	96416282
32-9-2	96416925	96416912
32-9	96416300	96416283
32-10-2	96416926	96416913
32-10	96416301	96416284
32-11-2	96416927	96416914
32-11	96416302	96416285
32-12-2	96416928	96416915
32-12	96416303	96416286

Pump type	CRN 32	CR 32
32-13-2	96416929	96416916
32-13	96416304	96416287
32-14-2	96416930	96416917
32-14	96416305	96416288

**Content**

Pos.	Description	Quantity
	Rotating unit	1

**Plug**

Pos.	Kit No	96505136
	Description	EPDM/FKM
18	Vent screw	1
23	Pipe plug	1
25	Pipe plug	4
38	O-ring 16.3 x 2.4	4
100	O-ring 16.3 x 2.4	2

CR, CRN 32

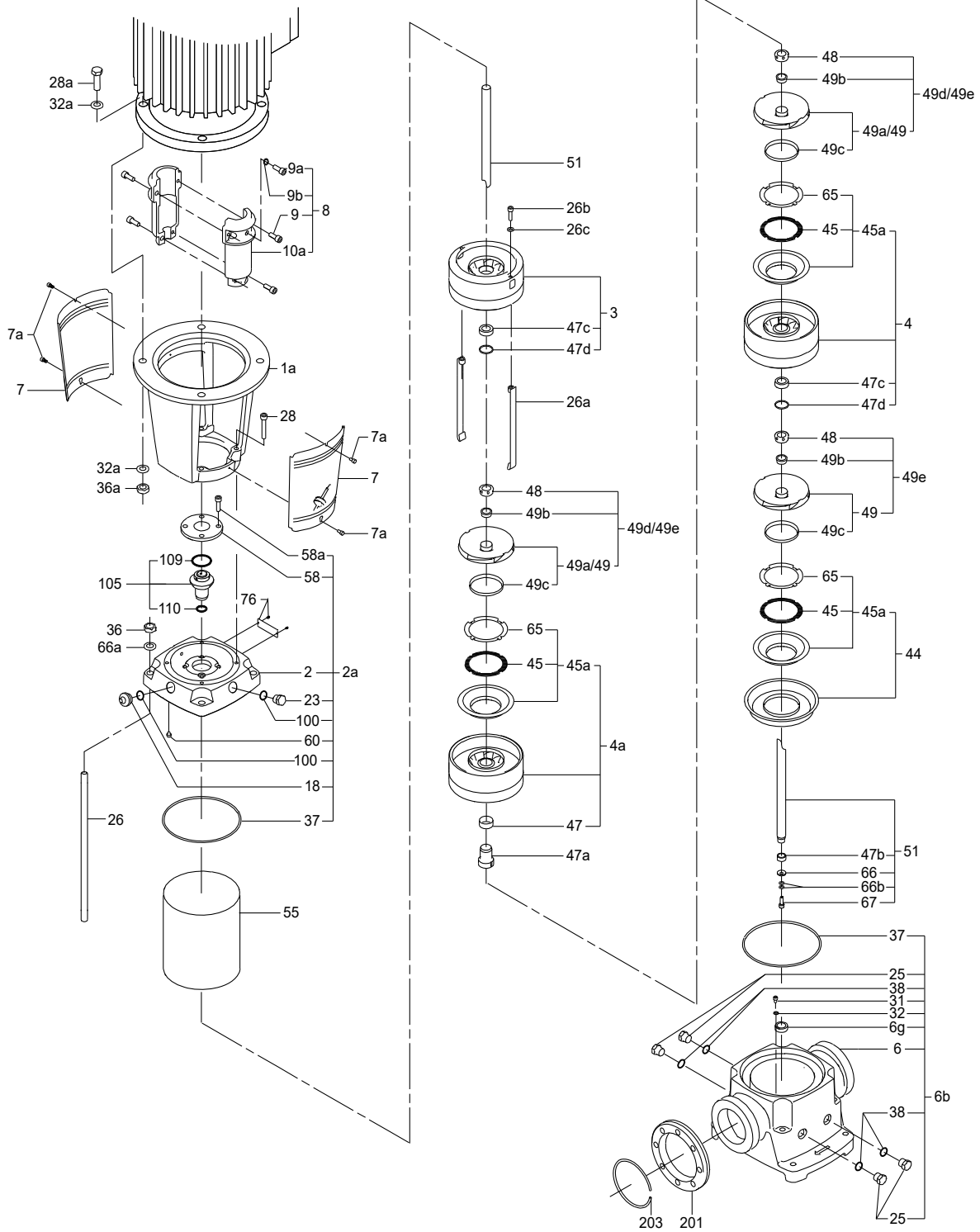

TM022299

**CR, CRN 32, model B****Chamber with bearing**

Type	Kit No	
	CR	CRN
SIC/SIC	<a href="#">98497462</a>	<a href="#">98633738</a>
Graflon/HM	<a href="#">98497463</a>	<a href="#">98633739</a>
Bronze/HM	<a href="#">98497464</a>	<a href="#">98633751</a>

**Content**

Pos.	Description	Quantity
4a	Chamber cpl.	1
47a	Rotating bearing	1

**Impeller**

Name	Kit No	
	CR	CRN
32	<a href="#">98497465</a>	<a href="#">98633780</a>

**Content**

Pos.	Description	Quantity
49	Impeller	1
48	Nut	1
48	Nut with slot	1
49b	Split cone	1

**Impeller reduced**

Name	Kit No	
	CR	CRN
32	<a href="#">98633832</a>	<a href="#">98633836</a>

**Content**

Pos.	Description	Quantity
49	Impeller	1
48	Nut	1
48	Nut with slot	1
49b	Split cone	1

**Inlet part**

Type	Kit No	
	CR	CRN
-	<a href="#">98633883</a>	<a href="#">98633886</a>

**Content**

Pos.	Description	Quantity
44	Inlet part cpl.	1

**Upper chamber with bearing**

Type	Kit No	
	CR	CRN
SIC/SIC	<a href="#">98633752</a>	<a href="#">98633758</a>
Graflon/HM	<a href="#">98633754</a>	<a href="#">98633759</a>
Bronze/HM	<a href="#">98633756</a>	<a href="#">98633777</a>

**Content**

Pos.	Description	Quantity
3	Upper chamber with bearing	1
47a	Rotating bearing	1

**Spare chamber**

Type	Kit No	
	CR	CRN
Graflon	<a href="#">98497466</a>	<a href="#">98633840</a>
Teflon	<a href="#">98497467</a>	<a href="#">98633862</a>
Bronze	<a href="#">98497468</a>	<a href="#">98497468</a>

**Content**

Pos.	Description	Quantity
4	chamber with bush	1

**Spare upper chamber**

Type	Kit No	
	CR	CRN
Graflon	<a href="#">98633863</a>	<a href="#">98633870</a>
Teflon	<a href="#">98633867</a>	<a href="#">98633882</a>
Bronze	<a href="#">98633868</a>	<a href="#">98633868</a>

**Content**

Pos.	Description	Quantity
3	Upper chamber with bush	1

**Wear parts**

Type	Kit No
Graflon	1-2 <a href="#">98497130</a>
	3-7 <a href="#">98497451</a>
	8-11 <a href="#">98497452</a>
	12-14 <a href="#">98497453</a>
Teflon	1-2 <a href="#">98497454</a>
	3-7 <a href="#">98497455</a>
	8-11 <a href="#">98497456</a>
Bronze	12-14 <a href="#">98497457</a>
	1-2 <a href="#">98497458</a>
	3-7 <a href="#">98497459</a>
	8-11 <a href="#">98497460</a>
	12-14 <a href="#">98497461</a>

**Content**

Pos.	Description	Stages	Quantity
45	Seal ring	1-2	2
		3-7	7
		8-11	11
		12-14	14
47c	Bush (Graflon)	1-2	1
		3-7	5
		8-11	8
		12-14	11
47d	Lock ring	1-2	2
		3-7	7
		8-11	11
		12-14	14
49c	Wear ring	1-2	2
		3-7	7
		8-11	11
		12-14	14
65	Top for neck ring N	1-2	2
		3-7	7
		8-11	11
		12-14	14
	Adjusting fork	1-2	1
		3-7	
		8-11	
		12-14	

CR, CRN 32, model B

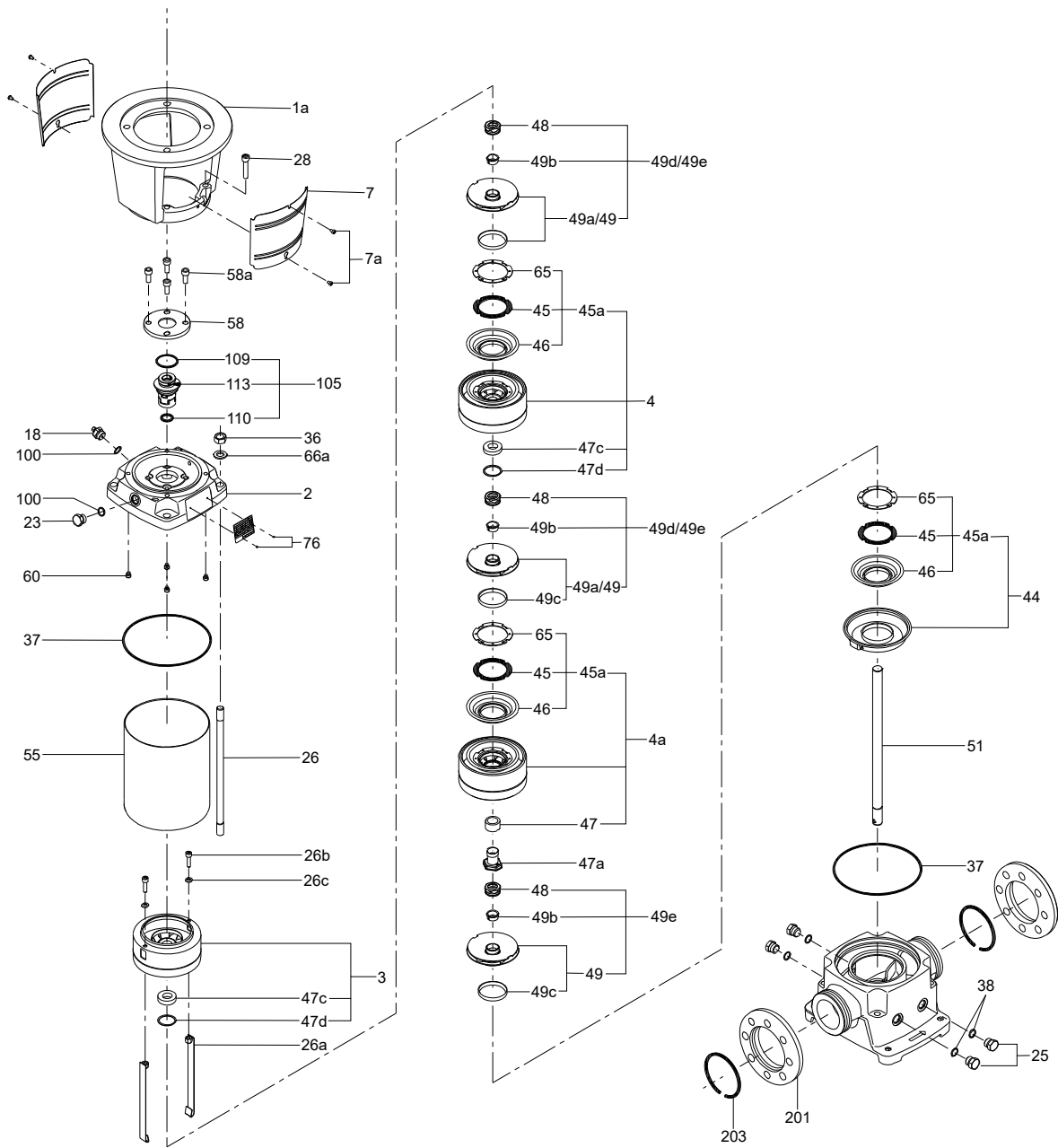

TM060570

**Coupling complete**

Kit No		96416589	96416590	96416591	96416592	96416593	96416594	96475477	96475478
Pos.	Motor/pump shaft diameter [mm]	24/22	28/22	38/22	42/22	48/22	55/22	42/22	48/22
Description		For shafts with key and keyway							
10a	Coupling half	2	2	2	2	2	2	2	2
9	Hexagon socket head screw	4	4	4	4	4	4	4	4
9a	Hexagon socket head screw	-	-	-	-	-	-	1	1
9b	Washer	-	-	-	-	-	-	1	1
	Adjusting fork	1	1	1	1	1	1	1	1

**Coupling complete NEMA**

Motor/pump shaft diameter	Kit No
28.6/22	96417000
34.9/22	96417001
41.2/22	96417004
47.6/22	96417020

**Content**

Pos.	Description	Quantity
10a	Coupling half	2
9	Hexagon socket head screw	4
-	Adjusting fork	1

**O-ring**

Description	Kit No
EPDM	96416597
FKM	96416598

**Content**

Pos.	Description	Quantity
37	O-ring	2
38	O-ring	4
60	Spring (rubber)	4
100	O-ring	2
109	O-ring	1
110	O-ring	1
-	Adjusting fork (shaft seal)	1

**Shaft seal**

Description	Kit No
HQQE	96525458
HQQV	96525490
HQQK	96533369
HQQF	96533412
HQBE	96525457
HQBV	96525459
HUBK	96533365
HUBF	96533366
HUUE	96436727
HUUV	96436728
HUUK	96533367
HUUF	96533368

**Content**

Pos.	Description	Quantity
105	Shaft seal	1

CR, CRN 32, model B

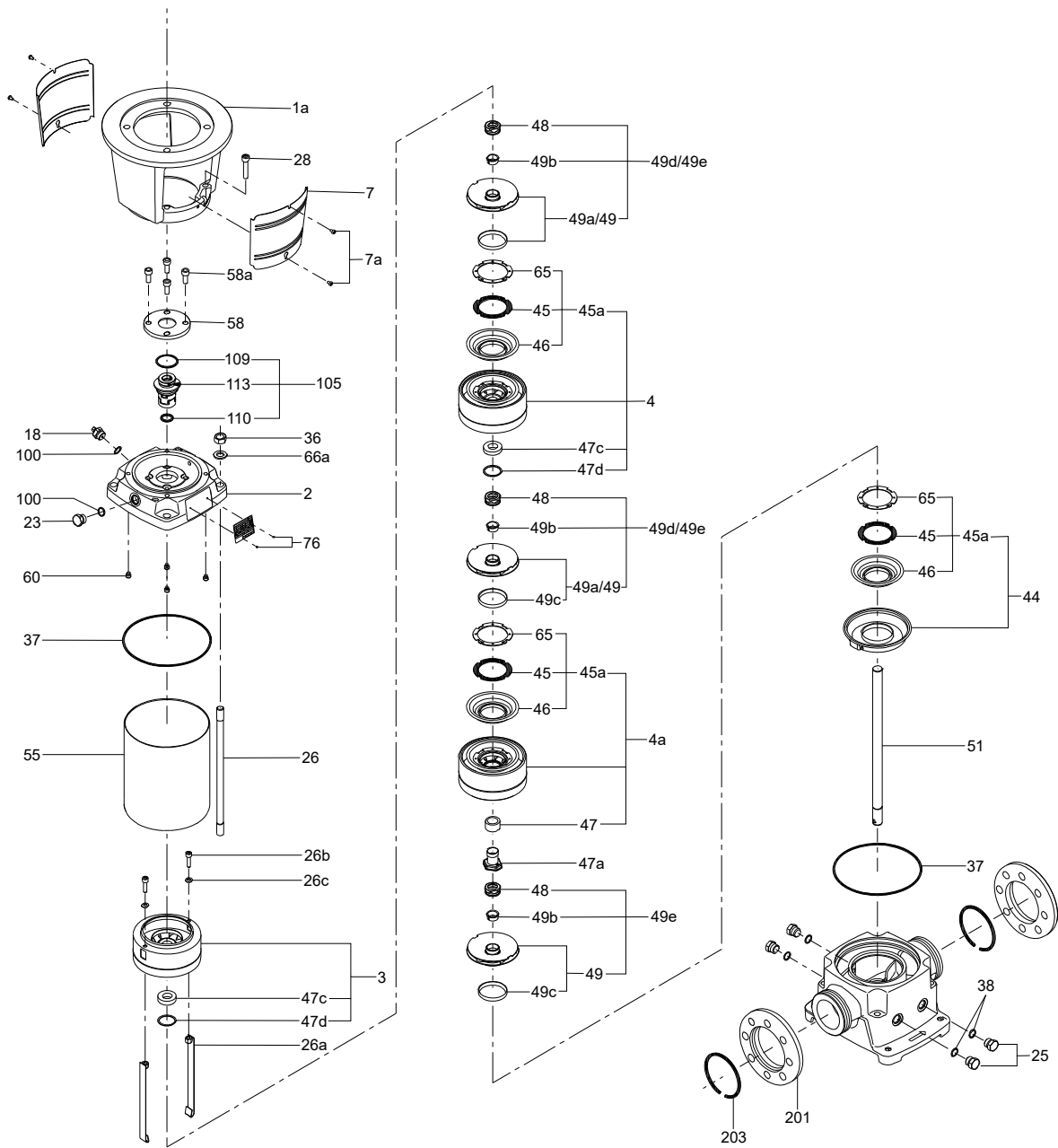

TM060570

**Chamber stack complete**

Pump type	CRN 32	CR 32
32-1-1	96416290	96416273
32-1	96416291	96416274
32-2-2	96416918	96416905
32-2-1	96416292	96416275
32-2	96416293	96416276
32-3-2	96416919	96416906
32-3	96416294	96416277
32-4-2	96416920	96416907
32-4	96416295	96416278
32-5-2	96416921	96416908
32-5	96416296	96416279
32-6-2	96416922	96416909
32-6	96416297	96416280
32-7-2	96416923	96416910
32-7	96416298	96416281
32-8-2	96416924	96416911
32-8	96416299	96416282
32-9-2	96416925	96416912
32-9	96416300	96416283
32-10-2	96416926	96416913
32-10	96416301	96416284
32-11-2	96416927	96416914
32-11	96416302	96416285
32-12-2	96416928	96416915
32-12	96416303	96416286
32-13-2	96416929	96416916
32-13	96416304	96416287
32-14-2	96416930	96416917
32-14	96416305	96416288

**Content**

Pos.	Description	Quantity
	Rotating unit	1

**Coupling guard**

Pos.	Kit No	96505134	96505135
	Description	MG 90 - MG 132	MG 160 - MG 225
7	Coupling guard	2	2
7a	Screw	4	4

**Plug**

Pos.	Kit No	96505136
	Description	EPDM/FKM
18	Vent screw	1
23	Pipe plug	1
25	Pipe plug	4
38	O-ring 16.3 x 2.4	4
100	O-ring 16.3 x 2.4	2



CR, CRN 32, model B

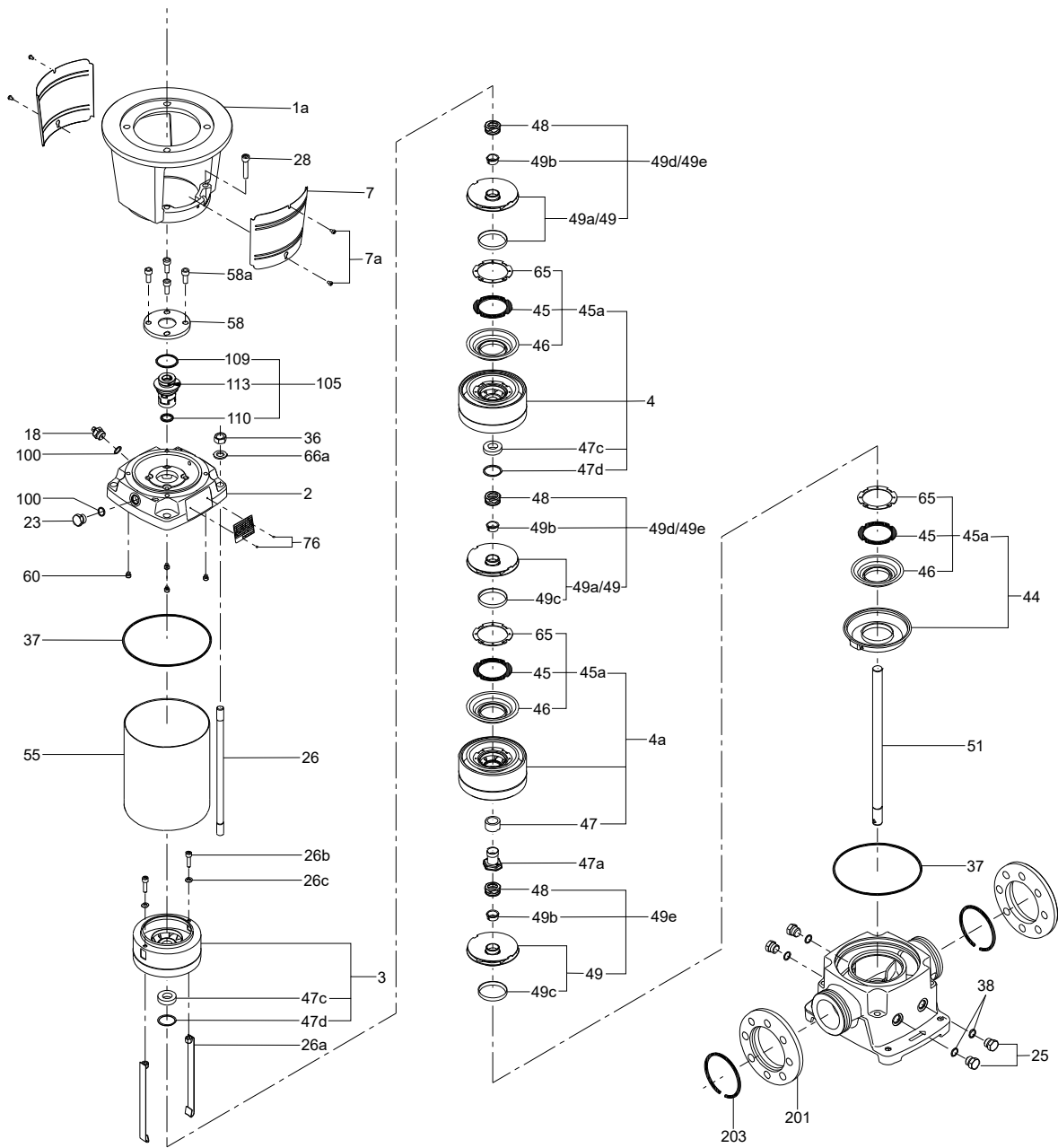

TM060570

## CR, CRN 45

### 50/60 Hz

#### Bearing

Kit No		96416577	96416578
Pos.	Number of stages	3-7	8-13
Description			
47a	Bearing	1	2
	Adjusting fork	1	1

#### Bottom bearing

Kit No		96416580
Pos.	Description	1-14
6g	Bearing ring (stationary)	1
31	Hexagon socket head screw	1
32	Washer	1
47b	Bearing ring (rotating)	1
66	Washer	1
66b	Lock washer	1
67	Hexagon socket head screw	1
D+E	Puller complete	1

#### O-ring

Description	Kit No
EPDM	96416599
FKM	96416600
FFKM	97800437

#### Content

Pos.	Description	Quantity
37	O-ring	2
38	O-ring	4
60	Spring (rubber)	4

#### Wear parts

Pos.	Kit No	96416732	96416733	96416734	96472046
	Description	1-2	3-7	8-10	11-13
45	Neck ring	2	7	10	13
47	Bearing (carbon-filled PTFE)		1	2	2
47	Bearing (bronze)		1	2	2
47c	Sleeve	2	6	8	11
47d	Lock ring	2	7	10	13
49c	Wear ring	2	7	10	13
65	Seal carrier	2	7	10	13
	Adjusting fork	1	1	1	1

Pos.	Description	Quantity
100	O-ring	2
109	O-ring	1
110	O-ring	1
	Adjusting fork (shaft seal)	1

#### Shaft seal

Description	Kit No
HQQE	96525458
HQQV	96525490
HQQK	96533369
HQQF	96533412
HQBE	96525457
HQBV	96525459
HUBK	96533365
HUBF	96533366
HUUE	96436727
HUUV	96436728
HUUK	96533367
HUUF	96533368

#### Content

Pos.	Description	Quantity
105	Shaft seal	1

CR, CRN 45

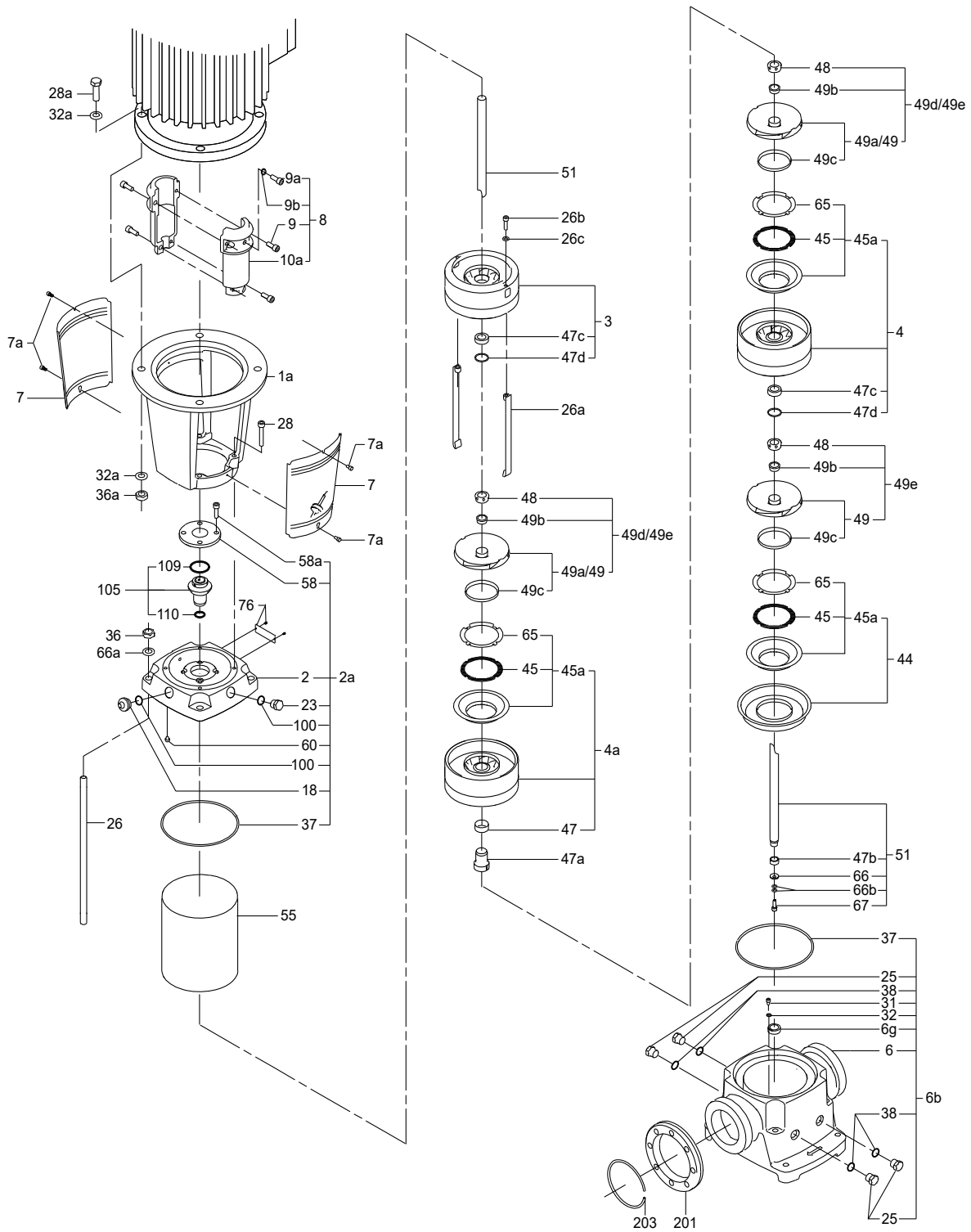

TM022299

**Chamber stack complete**

Pump type	CRN 45	CR 45
45-1-1	96416239	96416222
45-1	96416240	96416223
45-2-2	96416241	96416224
45-2-1	96416242	96416225
45-2	96416243	96416226
45-3-2	96416244	96416227
45-3-1	96416939	96416932
45-3	96416245	96416228
45-4-2	96416246	96416229
45-4-1	96416940	96416933
45-4	96416247	96416230
45-5-2	96416941	96416934
45-5-1	96416248	96416231
45-5	96416249	96416232
45-6-2	96416250	96416233
45-6	96416251	96416234
45-7-2	96416942	96416935
45-7-1	96613063	96613069
45-7	96416252	96416235
45-8-1	97910307	97910305
45-8-2	96416943	96416936
45-8	96416253	96416236
45-9-2	96416254	96416237
45-9	96416944	96416937
45-10-2	96416945	96416938
45-10	96416255	96416238

**Content**

Pos.	Description	Quantity
	Rotating assembly	1

**Coupling complete**

Kit No	96416590	96416591	96416592	96416593	96416594	96475477	96475478
Pos. Motor/pump shaft diameter [mm]	28/22	38/22	42/22	48/22	55/22	42/22	48/22
Description	For shafts with key and keyway						
10a Coupling half	2	2	2	2	2	2	2
9 Hexagon socket head screw	4	4	4	4	4	4	4
9a Hexagon socket head screw	-	-	-	-	-	1	1
9b Washer	-	-	-	-	-	1	1
Adjusting fork	1	1	1	1	1	1	1

**Coupling complete, NEMA**

Motor/pump shaft diameter	Kit No
34.9/22	96417001
41.2/22	96417004
47.6/22	96417020

**Content**

Pos.	Description	Quantity
10a	Coupling half	2
9	Hexagon socket head screw	4
	Adjusting fork	1

**Coupling guard**

Kit No	96505134	96505135
Pos. Description	MG 90 - MG 132	MG 160 - MG 225
7	Coupling guard	2

Kit No	96505134	96505135
Pos. Description	MG 90 - MG 132	MG 160 - MG 225
7a	Screw	4

**Plug**

Kit No	96505136	
Pos. Description	EPDM/FKM	
18	Vent screw	1
23	Pipe plug	1
25	Pipe plug	4
38	O-ring 16.3 x 2.4	4
100	O-ring 16.3 x 2.4	2

CR, CRN 45

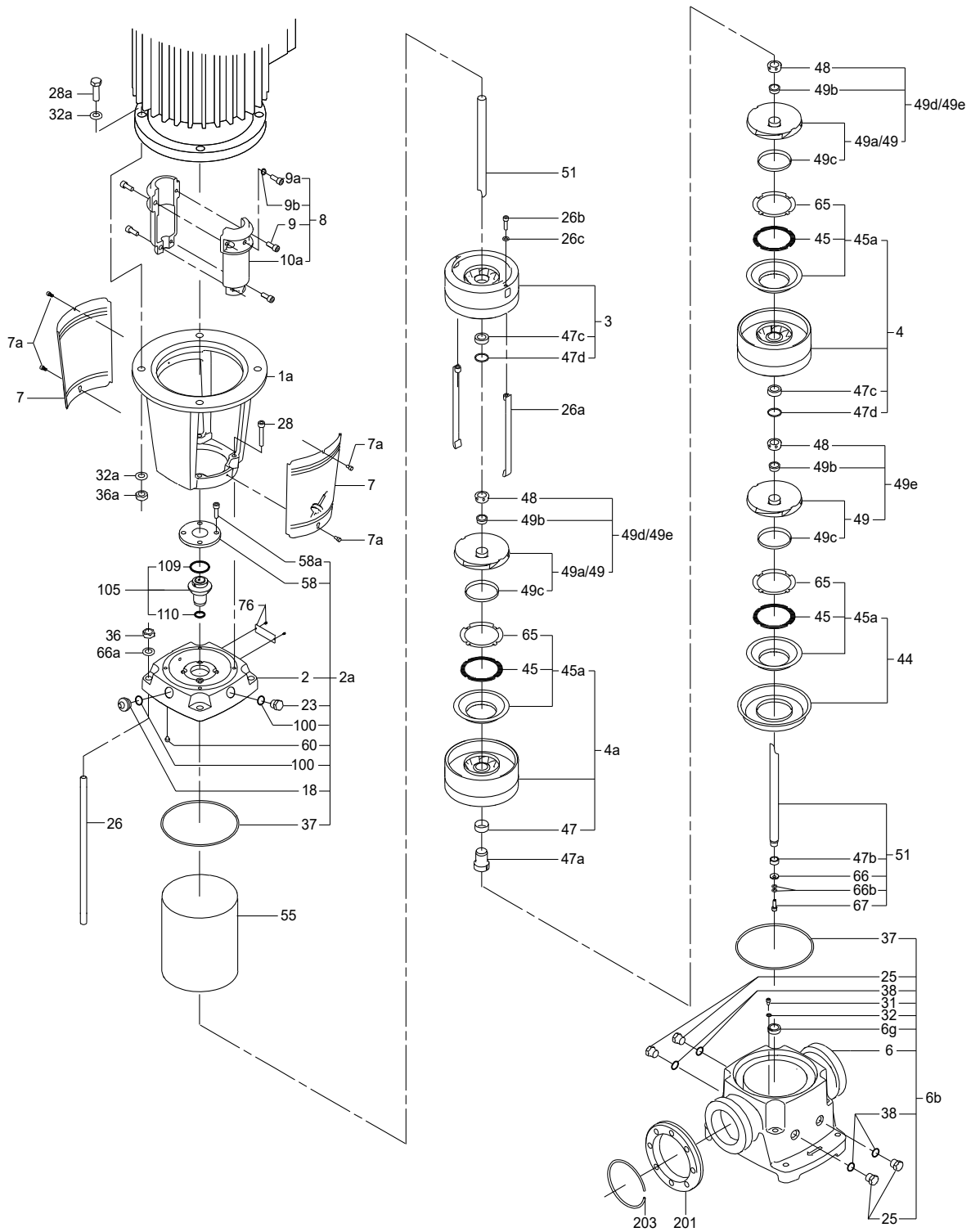

TM022299

**CR, CRN 45, model B****Chamber with bearing**

Type	Kit No	
	CR	CRN
SIC/SIC	98497485	98633888
Graflon/HM	98497486	98633889
Bronze/HM	98497487	98633981

Pos.	Description	Quantity
4a	Chamber cpl.	1
47a	Rotating bearing	1

**Impeller**

Name	Kit No	
	CR	CRN
49	98497488	98634001

**Content**

Pos.	Description	Quantity
49	Impeller	1
48	Nut	1
48	Nut with slot	1
49b	Split cone	1

**Impeller reduced**

Name	Kit No	
	CR	CRN
49a	98634014	98634018

**Content**

Pos.	Description	Quantity
49a	Impeller	1
48	Nut	1
48	Nut with slot	1
49b	Split cone	1

**Inlet part**

Type	Kit No	
	CR	CRN
-	98634054	98634055

**Content**

Pos.	Description	Quantity
44	Inlet part cpl.	1

**Upper chamber with bearing**

Type	Kit No	
	CR	CRN
SIC/SIC	98633982	98633988
HY49/HM	98633986	98633989
Bronze/HM	98633987	98633990

**Content**

Pos.	Description	Quantity
3	Upper chamber cpl.	1
47a	Bearing cpl.	1

**Spare chamber**

Type	Kit No	
	CR	CRN
Graflon	98497489	98634020
Teflon	98497490	98634032
Bronze	98497491	98497491

**Content**

Pos.	Description	Quantity
4	Chamber with bush	1

**Spare upper chamber**

Type	Kit No	
	CR	CRN
Graflon	98634042	98634048
Teflon	98634043	98634051
Bronze	98634046	98634046

**Content**

Pos.	Description	Quantity
3	Upper chamber with bush	1

**Wear parts**

Type	Kit No	
Graflon	1-2	98497473
	3-7	98497474
	8-10	98497475
	11-13	98497476
Teflon	1-2	98497477
	3-7	98497478
	8-10	98497479
Bronze	11-13	98497480
	1-2	98497481
	3-7	98497482
	8-10	98497483
	11-13	98497484

**Content**

Pos.	Description	Stages	Quantity
45	Seal ring	1-2	2
		3-7	7
		8-10	10
		11-13	13
47c	Bush	1-2	1
		3-7	5
		8-10	7
		11-13	10
47d	Lock ring	1-2	2
		3-7	7
		8-10	10
		11-13	13
49c	Wear ring	1-2	2
		3-7	7
		8-10	10
		11-13	13
65	Top for neck ring N	1-2	2
		3-7	7
		8-10	10
		11-13	13
-	Adjusting fork	1-2 3-7 8-10 11-13	1

CR, CRN 45, model B



TM060570



**Coupling complete**

Kit No		96416590	96416591	96416592	96416593	96416594	96475477	96475478
Pos.	Motor/pump shaft diameter [mm]	28/22	38/22	42/22	48/22	55/22	42/22	48/22
Description		For shafts with key and keyway						
10a	Coupling half	2	2	2	2	2	2	2
9	Hexagon socket head screw	4	4	4	4	4	4	4
9a	Hexagon socket head screw	-	-	-	-	-	1	1
9b	Washer	-	-	-	-	-	1	1
	Adjusting fork	1	1	1	1	1	1	1

**Coupling complete, NEMA**

Motor/pump shaft diameter	Kit No
34.9/22	96417001
41.2/22	96417004
47.6/22	96417020

**Content**

Pos.	Description	Quantity
10a	Coupling half	2
9	Hexagon socket head screw	4
	Adjusting fork	1

**O-ring**

Description	Kit No
EPDM	96416599
FKM	96416600
FFKM	97800437

**Content**

Pos.	Description	Quantity
37	O-ring	2
38	O-ring	4
60	Spring (rubber)	4
100	O-ring	2
109	O-ring	1
110	O-ring	1
	Adjusting fork (shaft seal)	1

**Shaft seal**

Description	Kit No
HQQE	96525458
HQQV	96525490
HQQK	96533369
HQQF	96533412
HQBE	96525457
HQBV	96525459
HUBK	96533365
HUBF	96533366
HUUE	96436727
HUUV	96436728
HUUK	96533367
HUUF	96533368

**Content**

Pos.	Description	Quantity
105	Shaft seal	1

CR, CRN 45, model B

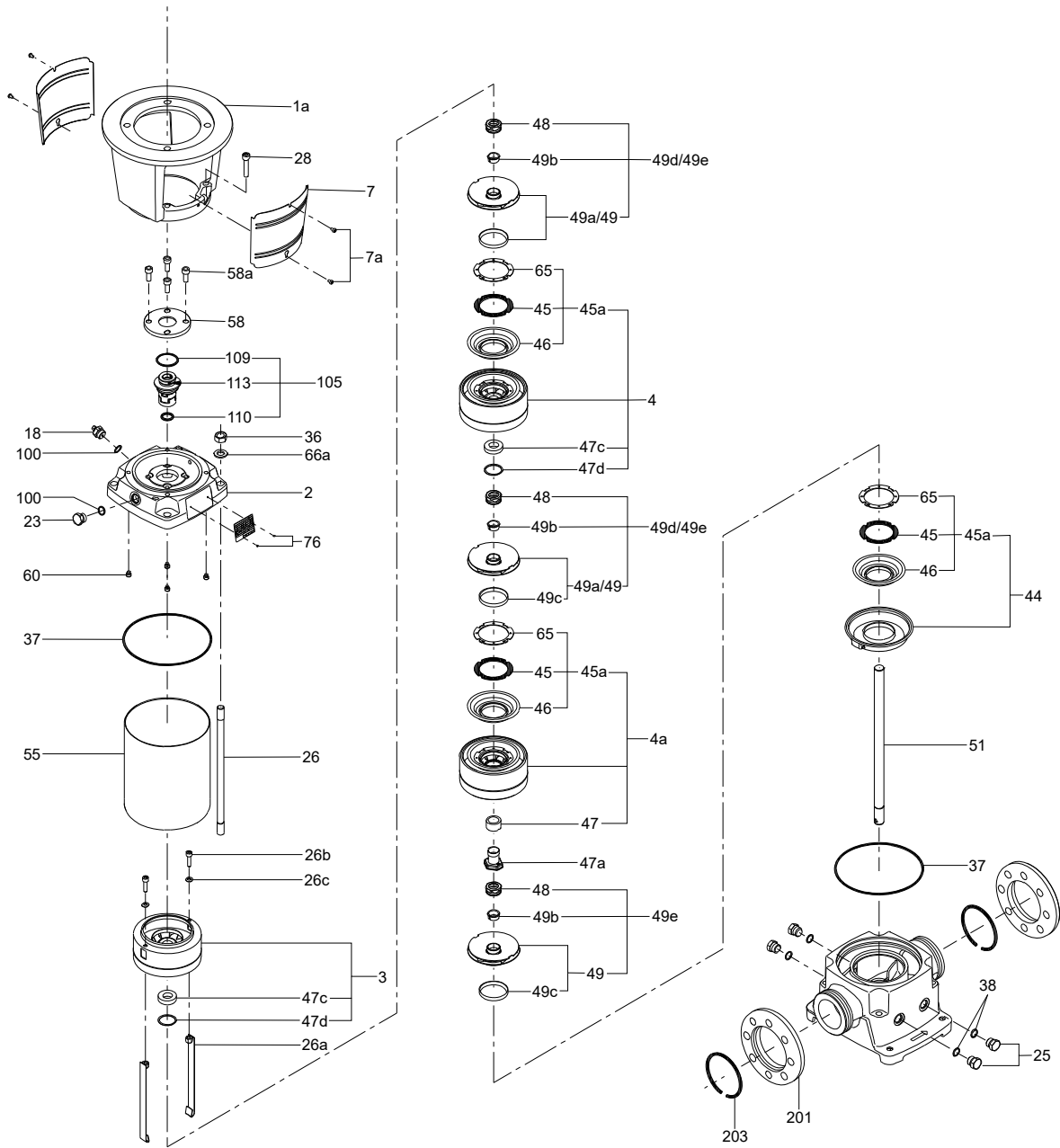

TM060570

**Chamber stack complete**

Pumptype	CRN 45	CR 45
45-1-1	96416239	96416222
45-1	96416240	96416223
45-2-2	96416241	96416224
45-2-1	96416242	96416225
45-2	96416243	96416226
45-3-2	96416244	96416227
45-3-1	96416939	96416932
45-3	96416245	96416228
45-4-2	96416246	96416229
45-4-1	96416940	96416933
45-4	96416247	96416230
45-5-2	96416941	96416934
45-5-1	96416248	96416231
45-5	96416249	96416232
45-6-2	96416250	96416233
45-6	96416251	96416234
45-7-2	96416942	96416935
45-7-1	96613063	96613069
45-7	96416252	96416235
45-8-1	97910307	97910305
45-8-2	96416943	96416936
45-8	96416253	96416236
45-9-2	96416254	96416237
45-9	96416944	96416937
45-10-2	96416945	96416938
45-10	96416255	96416238

**Content**

Pos.	Description	Quantity
	Rotating assembly	1

**Coupling guard**

Pos.	Kit No	96505134	96505135
	Description	MG 90 - MG 132	MG 160 - MG 225
7	Coupling guard	2	2
7a	Screw	4	4

**Plug**

Pos.	Kit No	96505136
	Description	EPDM/FKM
18	Vent screw	1
23	Pipe plug	1
25	Pipe plug	4
38	O-ring 16.3 x 2.4	4
100	O-ring 16.3 x 2.4	2

CR, CRN 45, model B

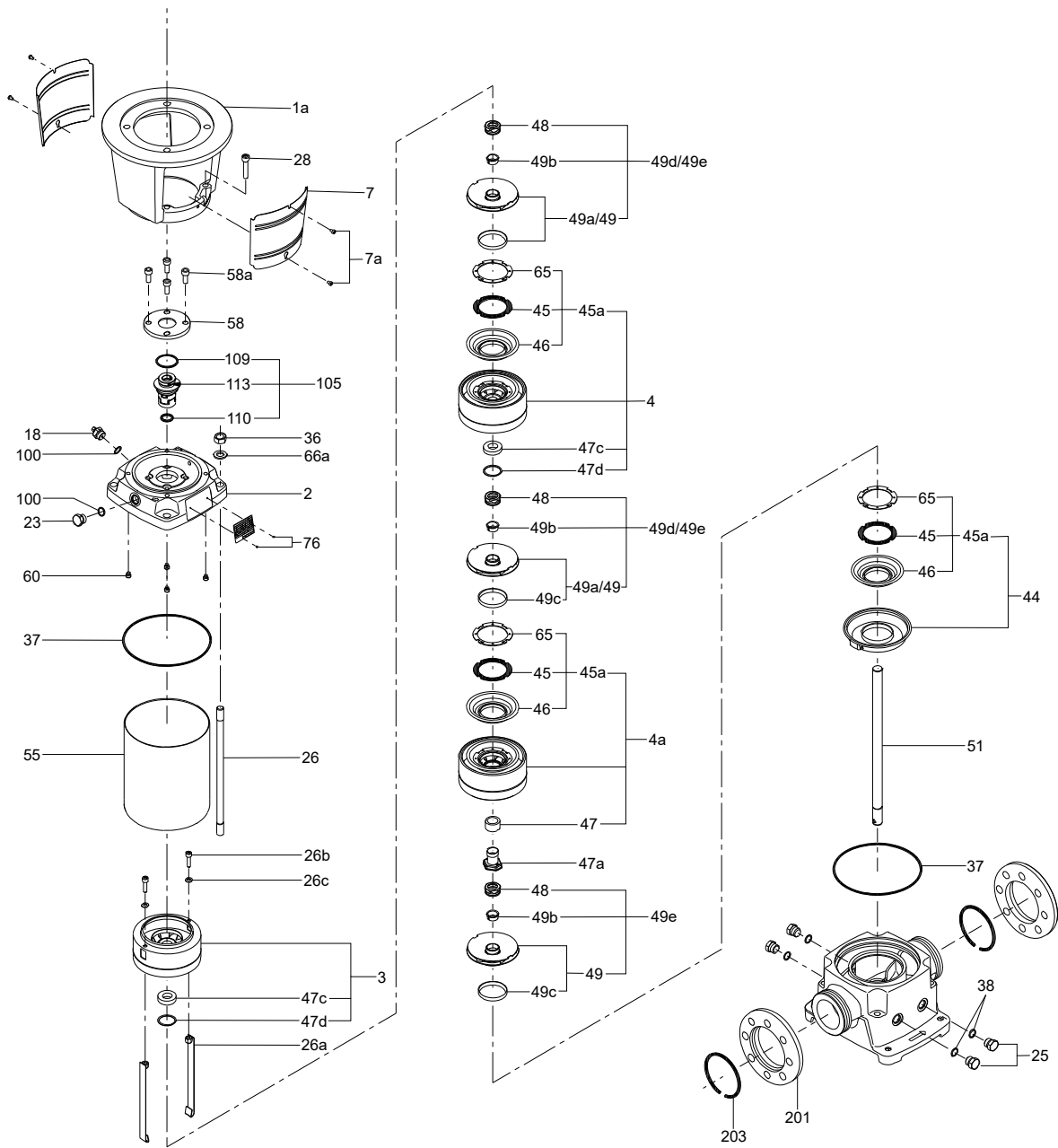

TM060570

## CR, CRN 64

### 50/60 Hz

#### Bearing

	Kit No	96416573
Pos.	Number of stages	3-8
	Description	
47a	Bearing	1
-	Adjusting fork	1

#### Bottom bearing

	Kit No	96416580
Pos.	Description	1-14
6g	Bearing ring (stationary)	1
31	Hexagon socket head screw	1
32	Washer	1
47b	Bearing ring (rotating)	1
66	Washer	1
66b	Lock washer	1
67	Hexagon socket head screw	1
D + E	Puller complete	1
-	Adjusting fork	1

#### Coupling guard

	Kit No	96505134	96505135
Pos.	Description	MG 90 - MG 132	MG 160 - MG 225
7	Coupling guard	2	2
7a	Screw	4	4

#### O-ring

Description	Kit No
EPDM	96416599
FKM	96416600
FFKM	97800437

#### Content

Pos.	Description	Quantity
37	O-ring	2
38	O-ring	4
60	Spring (rubber)	4
100	O-ring	2
109	O-ring	1
110	O-ring	1
-	Adjusting fork (shaft seal)	1

#### Shaft seal

Description	Kit No
HQQE	96525458
HQQV	96525490
HQQK	96533369
HQQF	96533412
HQBE	96525457
HQBV	96525459
HUBK	96533365
HUBF	96533366
HUUE	96436727
HUUV	96436728
HUUK	96533367
HUUF	96533368

#### Content

Pos.	Description	Quantity
105	Shaft seal	1

#### Wear parts

	Kit No	96416735	96416736
Pos.	Description	1-2	3-8
45	Neck ring	2	8
47	Bearing (carbon-filled PTFE)	-	2
47	Bearing (bronze)	-	2
47c	Sleeve	2	7
47d	Lock ring	2	8
49c	Wear ring	2	8
65	Seal carrier	2	8
	Adjusting fork	1	1

CR, CRN 64

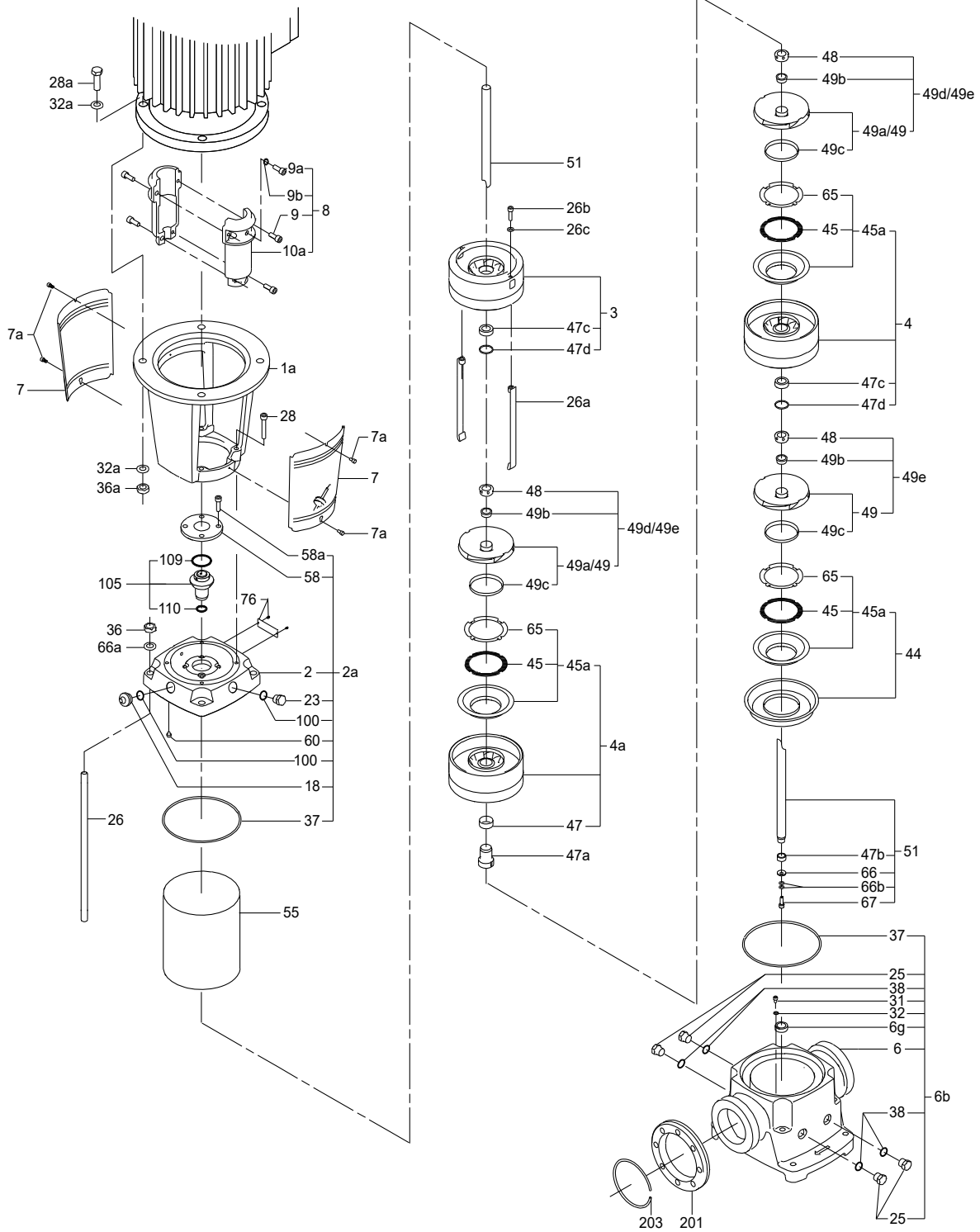

TM022299

**Chamber stack complete**

Pumptype	CRN 64	CR 64
64-1-1	96416326	96416307
64-1	96416327	96416308
64-2-2	96416328	96416309
64-2-1	96416329	96416310
64-2	96416330	96416311
64-3-2	96416331	96416312
64-3-1	96416332	96416313
64-3	96416333	96416314
64-4-2	96416334	96416315
64-4-1	96416335	96416316
64-4	96416336	96416317
64-5-2	96416337	96416318
64-5-1	96416338	96416319
64-5	96416339	96416320
64-6-2	96416340	96416321
64-6-1	96416341	96416322
64-6	96416342	96416323
64-7-2	96416343	96416324
64-7-1	96416344	96416325

**Content**

Pos.	Description	Quantity
	Rotating assembly	1

**Coupling complete**

Kit No		96416590	96416591	96416592	96416593	96416594	96475477	96475478
Pos.	Motor/pump shaft diameter [mm]	28/22	38/22	42/22	48/22	55/22	42/22	48/22
Description		For shafts with key and keyway						
10a	Coupling half	2	2	2	2	2	2	2
9	Hexagon socket head screw	4	4	4	4	4	4	4
9a	Hexagon socket head screw	-	-	-	-	-	1	1
9b	Washer	-	-	-	-	-	1	1
	Adjusting fork	1	1	1	1	1	1	1

**Coupling complete NEMA**

Motor/pump shaft diameter	Kit No
34.9/22	96417001
41.2/22	96417004
47.6/22	96417020

**Content**

Pos.	Description	Quantity
10a	Coupling half	2
9	Hexagon socket head screw	4
	Adjusting fork	1

**Plug**

Pos.	Kit No	96505136
Description		EPDM/FKM
18	Vent screw	1
23	Pipe plug	1
25	Pipe plug	4
38	O-ring 16.3 x 2.4	4
100	O-ring 16.3 x 2.4	2

CR, CRN 64

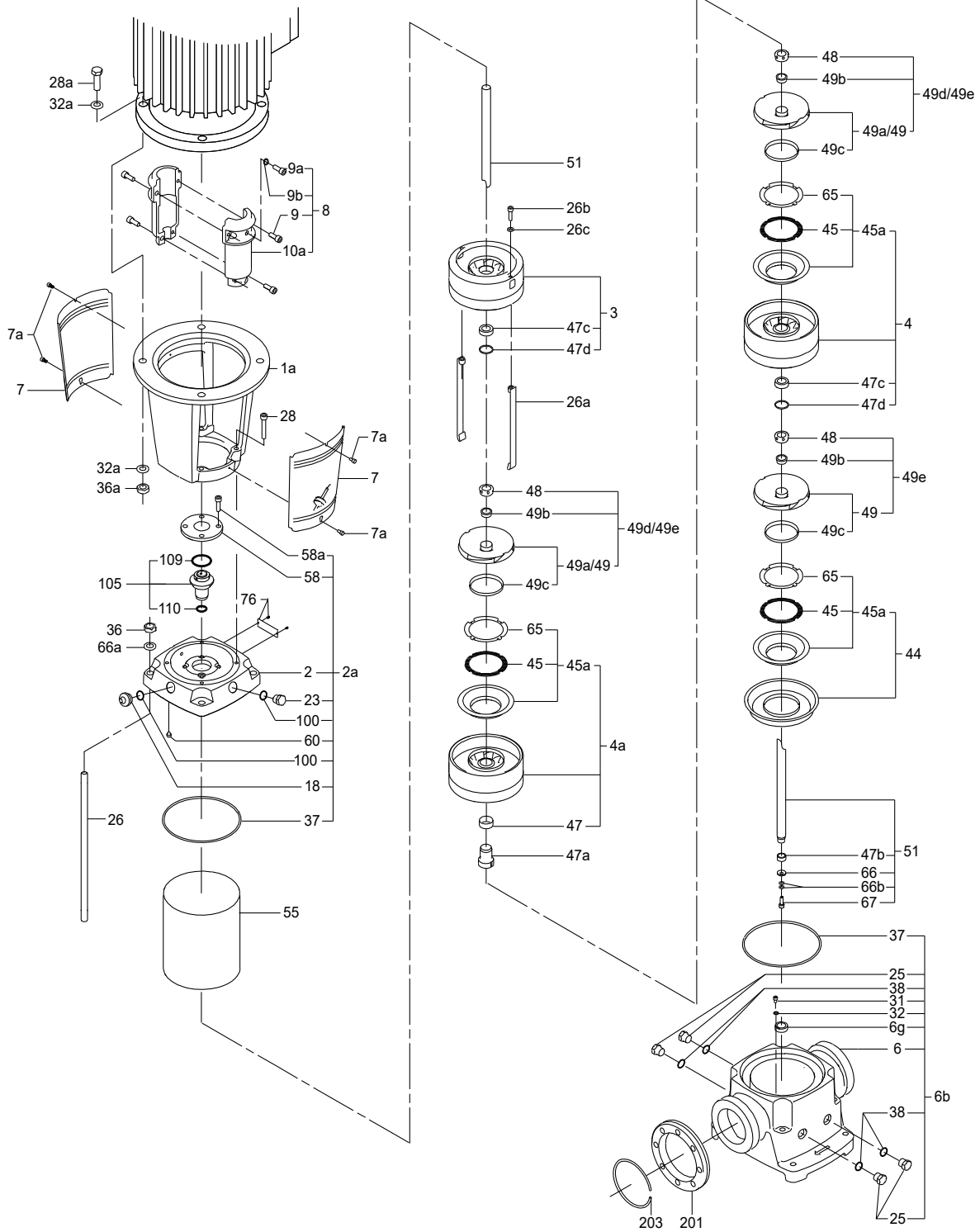

TM022299



**CR, CRN 64, model B****O-ring**

Description	Kit No
EPDM	96416599
FKM	96416600
FFKM	97800437

**Content**

Pos.		Quantity
37	O-ring	2
38	O-ring	4
60	Spring (rubber)	4
100	O-ring	2
109	O-ring	1
110	O-ring	1
-	Adjusting fork (shaft seal)	1

**Plug**

Pos.	Kit No	96505136
	Description	EPDM/FKM
18	Vent screw	1
23	Pipe plug	1
25	Pipe plug	4
38	O-ring 16.3 x 2.4	4
100	O-ring 16.3 x 2.4	2

**Spare chamber**

Type	Kit No	
	CR	CRN
Graflon	98497504	98634095
Teflon	98497505	98634142
Bronze	98497506	98497506

**Content**

Pos.	Description	Quantity
4	Chamber with bush	1

**Spare upper chamber**

Type	Kit No	
	CR	CRN
Graflon	98634144	98634150
Teflon	98634146	98634151
Bronze	98634148	98634148

**Content**

Pos.	Description	Quantity
3	Upper chamber with bush	1

**Shaft seal**

Description	Kit No
HQQE	96525458
HQQV	96525490
HQKQ	96533369
HQQF	96533412
HQBE	96525457
HQBV	96525459
HUBK	96533365

Description	Kit No
HUBF	96533366
HUUE	96436727
HUUV	96436728
HUUK	96533367
HUUF	96533368

**Content**

Pos.	Description	Quantity
105	Shaft seal	1

**Wear parts**

Type	Kit No	
Graflon	1-2	98497494
	3-8	98497495
Teflon	1-2	98497496
	3-8	98497497
Bronze	1-2	98497498
	3-8	98497499

**Content**

Pos.	Description	Stages	Quantity
45	Seal ring	1-2	2
		3-8	8
47c	Bush	1-2	1
		3-8	6
47d	Lock ring	1-2	2
		3-8	8
49c	Wear ring	1-2	2
		3-8	8
65	Top for neck ring N	1-2	2
		3-8	8
-	Adjusting fork	1-2	1
		3-8	

**Upper chamber with bearing**

Type	Kit No	
	CR	CRN
SIC/SIC	98634071	98634076
HY49/HM	98634072	98634077
Bronze/HM	98634074	98634078

**Content**

Pos.	Description	Quantity
3	Upper chamber cpl.	1
47a	Bearing cpl.	1

CR, CRN 64, model B

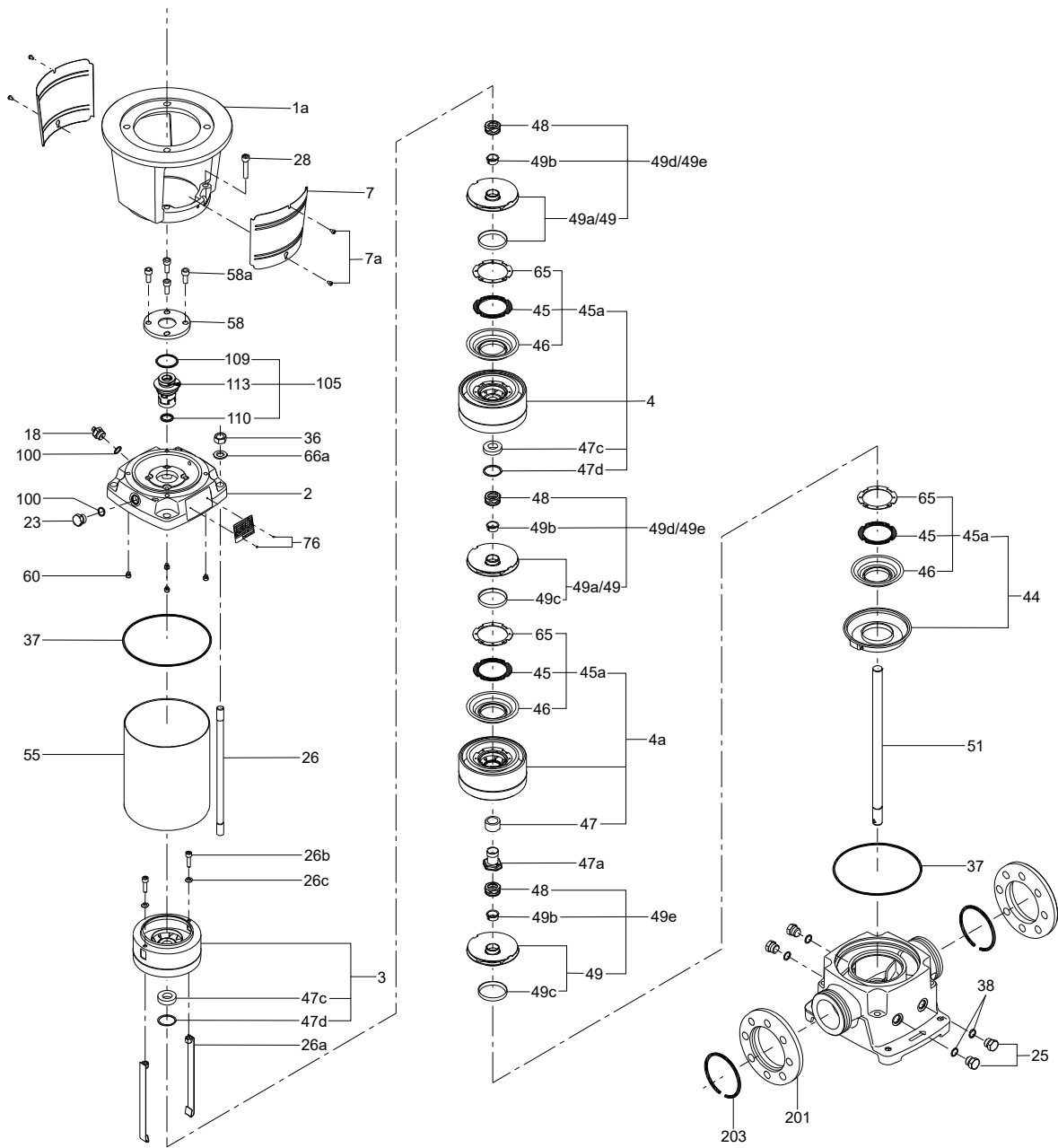

TM060570

**Chamber stack complete**

Pump type	CRN 64	CR 64
64-1-1	96416326	96416307
64-1	96416327	96416308
64-2-2	96416328	96416309
64-2-1	96416329	96416310
64-2	96416330	96416311
64-3-2	96416331	96416312
64-3-1	96416332	96416313
64-3	96416333	96416314
64-4-2	96416334	96416315
64-4-1	96416335	96416316
64-4	96416336	96416317
64-5-2	96416337	96416318
64-5-1	96416338	96416319
64-5	96416339	96416320
64-6-2	96416340	96416321
64-6-1	96416341	96416322
64-6	96416342	96416323
64-7-2	96416343	96416324
64-7-1	96416344	96416325

**Content**

Pos.	Description	Quantity
	Rotating assembly	1

**Chamber with bearing**

Type	Kit No	
	CR	CRN
SIC/SIC	98497500	98634056
Graflon/HM	98497501	98634058
Bronze/HM	98497502	98634059

**Content**

Pos.	Description	Quantity
4a	Chamber cpl.	1
47a	Rotating bearing	1

**Coupling complete**

Kit No		96416590	96416591	96416592	96416593	96416594	96475477	96475478
Pos.	Motor/pump shaft diameter [mm]	28/22	38/22	42/22	48/22	55/22	42/22	48/22
Description		For shafts with key and keyway						
10a	Coupling half	2	2	2	2	2	2	2
9	Hexagon socket head screw	4	4	4	4	4	4	4
9a	Hexagon socket head screw	-	-	-	-	-	1	1
9b	Washer	-	-	-	-	-	1	1
	Adjusting fork	1	1	1	1	1	1	1

**Coupling complete NEMA**

Motor/pump shaft diameter	Kit No
34.9/22	96417001
41.2/22	96417004
47.6/22	96417020

**Content**

Pos.	Description	Quantity
10a	Coupling half	2
9	Hexagon socket head screw	4
	Adjusting fork	1

**Coupling guard**

Pos.	Kit No	96505134	96505135
	Description	MG 90 - MG 132	MG 160 - MG 225
7	Coupling guard	2	2
7a	Screw	4	4

**Impeller**

Name	Kit No	
	CR	CRN
	98497503	98634079

**Content**

Pos.	Description	Quantity
49	Impeller	1
48	Nut	1
48	Nut with slot	1
49b	Split cone	1

**Impeller reduced**

Name	Kit No	
	CR	CRN
	98634080	98634093

**Content**

Pos.	Description	Quantity
49	Impeller	1
48	Nut	1
48	Nut with slot	1
49b	Split cone	1

**Inlet part**

Type	Kit No	
	CR	CRN
-	98634152	98634153

**Content**

<b>Pos.</b>	<b>Description</b>	<b>Quantity</b>
44	Inlet part cpl.	1

CR, CRN 64, model B

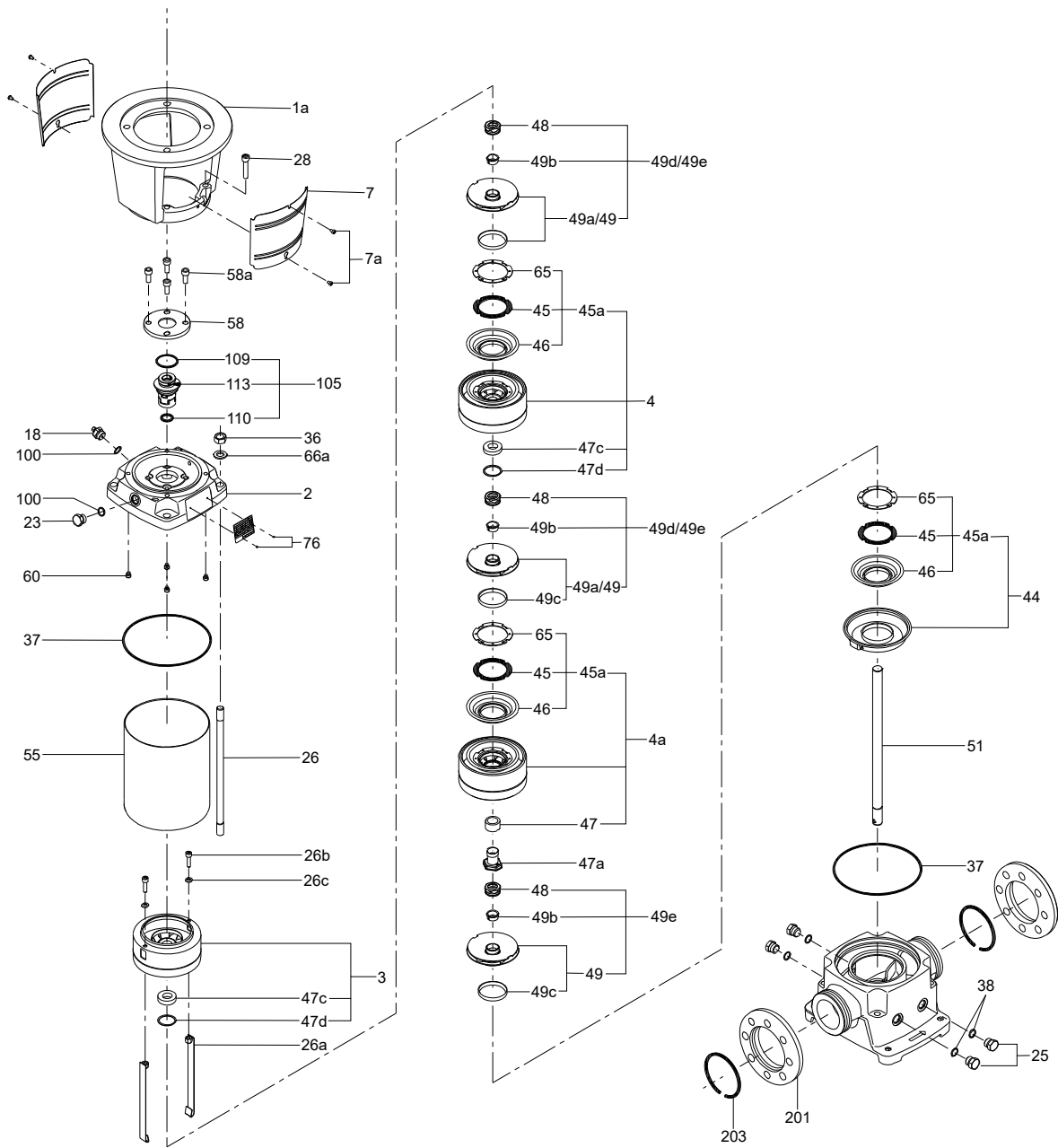

TM060570

## CR, CRN 90

### 50/60 Hz

#### Bearing

	Kit No	96416579
Pos.	Number of stages	3-6
	Description	
47a	Bearing	1
-	Adjusting fork	1

#### Bottom bearing

	Kit No	96416580
Pos.	Description	1-14
6g	Bearing ring (stationary)	1
31	Hexagon socket head screw	1
32	Washer	1
47b	Bearing ring (rotating)	1
66	Washer	1
66b	Lock washer	1
67	Hexagon socket head screw	1
D + E	Puller complete	1
-	Adjusting fork	1

#### Coupling guard

Pos.	Kit No	96505134	96505135
		MG 90 - MG 132	MG 160 - MG 225
7	Coupling guard	2	2
7a	Screw	4	4

#### Impeller 1. stage

Type	Standard	Reduced
Standard	98593752	98593755
Teflon	98593759	98593761
Electro pol.	98593764	98593769

#### Content

Pos.	Description	Quantity
49	Impeller	1
	Suction interconnector	1
	Nut for hub with spring	1

#### O-ring

Description	Kit No
EPDM	96416601
FKM	96416602

#### Content

Pos.	Description	Quantity
37	O-ring	2
38	O-ring	4
60	Spring (rubber)	4
100	O-ring	2
109	O-ring	1
110	O-ring	1
-	Adjusting fork (shaft seal)	1

#### Shaft seal

Description	Kit No
HQQE	96525458
HQQV	96525490
HQQK	96533369
HQQF	96533412
HQBE	96525457
HQBV	96525459
HUBK	96533365
HUBF	96533366
HUUE	96436727
HUUV	96436728
HUUK	96533367
HUUF	96533368

#### Content

Pos.	Description	Quantity
105	Shaft seal	1

#### Wear parts

Pos.	Kit No	96416737	96416738
		Description / number of stages	1-2
45	Neck ring	2	6
47	Bearing (carbon-filled PTFE)	-	1
47	Bearing bronze	-	1
47c	Sleeve	2	5
47d	Lock ring	2	6
49c	Wear ring	2	6
65	Seal carrier	2	6
	Adjusting fork	1	1

CR, CRN 90

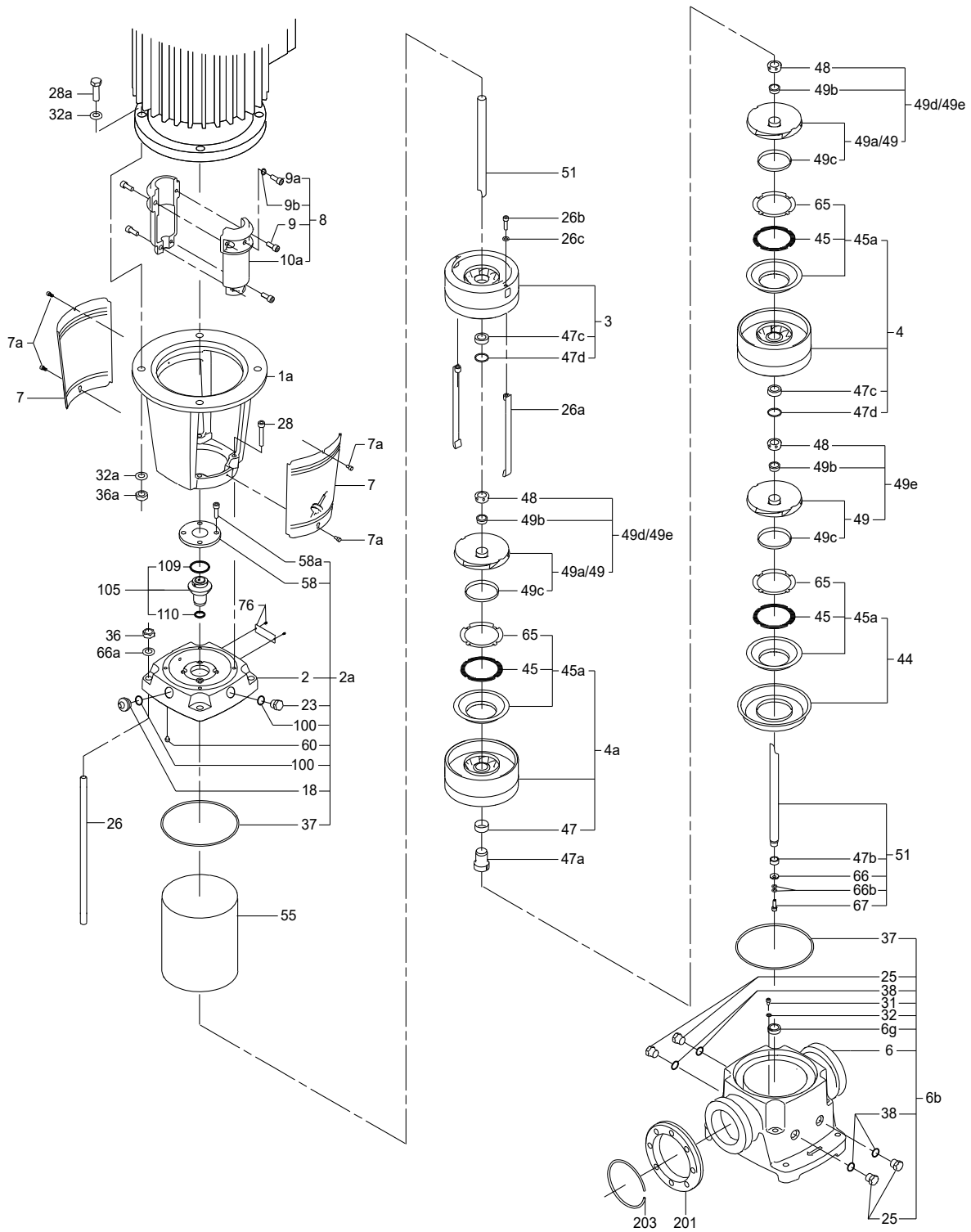

TM022299

**Chamber stack complete**

Pump type	CRN 90	CR 90
90-1	96458125	96416257
90-1-1	96458124	96416256
90-2	96458128	96416260
90-2-1	96458127	96416259
90-2-2	96458126	96416258
90-3	96458131	96416263
90-3-1	96458130	96416262
90-3-2	96458129	96416261
90-4	96458134	96416266
90-4-1	96458133	96416265
90-4-2	96458132	96416264
90-5	96458136	96416269
90-5-1	96493483	96416268
90-5-2	96458135	96416267
90-6	96458138	96416272
90-6-1	96465601	96416271
90-6-2	96458137	96416270

**Content**

Pos.	Description	Quantity
80	Rotating assembly	1

**Coupling complete**

Pos.	Kit No	96416591	96416592	96416593	96416594	96475477	96475478
	Motor/pump shaft diameter [mm]	38/22	42/22	48/22	55/22	42/22	48/22
Description		For shafts with key and keyway					
10a	Coupling half	2	2	2	2	2	2
9	Hexagon socket head screw	4	4	4	4	4	4
9a	Hexagon socket head screw	-	-	-	-	1	1
9b	Washer	-	-	-	-	1	1
	Adjusting fork	1	1	1	1	1	1

**Coupling complete NEMA**

Motor/pump shaft diameter	Kit No
41.2/22	96417004
47.6/22	96417020

**Content**

Pos.	Description	Quantity
10a	Coupling half	2
9	Hexagon socket head screw	4
	Adjusting fork	1

**Plug**

Pos.	Kit No	96505136
	Description	EPDM/FKM
18	Vent screw	1
23	Pipe plug	1
25	Pipe plug	4
38	O-ring 16.3 x 2.4	4
100	O-ring 16.3 x 2.4	2



CR, CRN 90

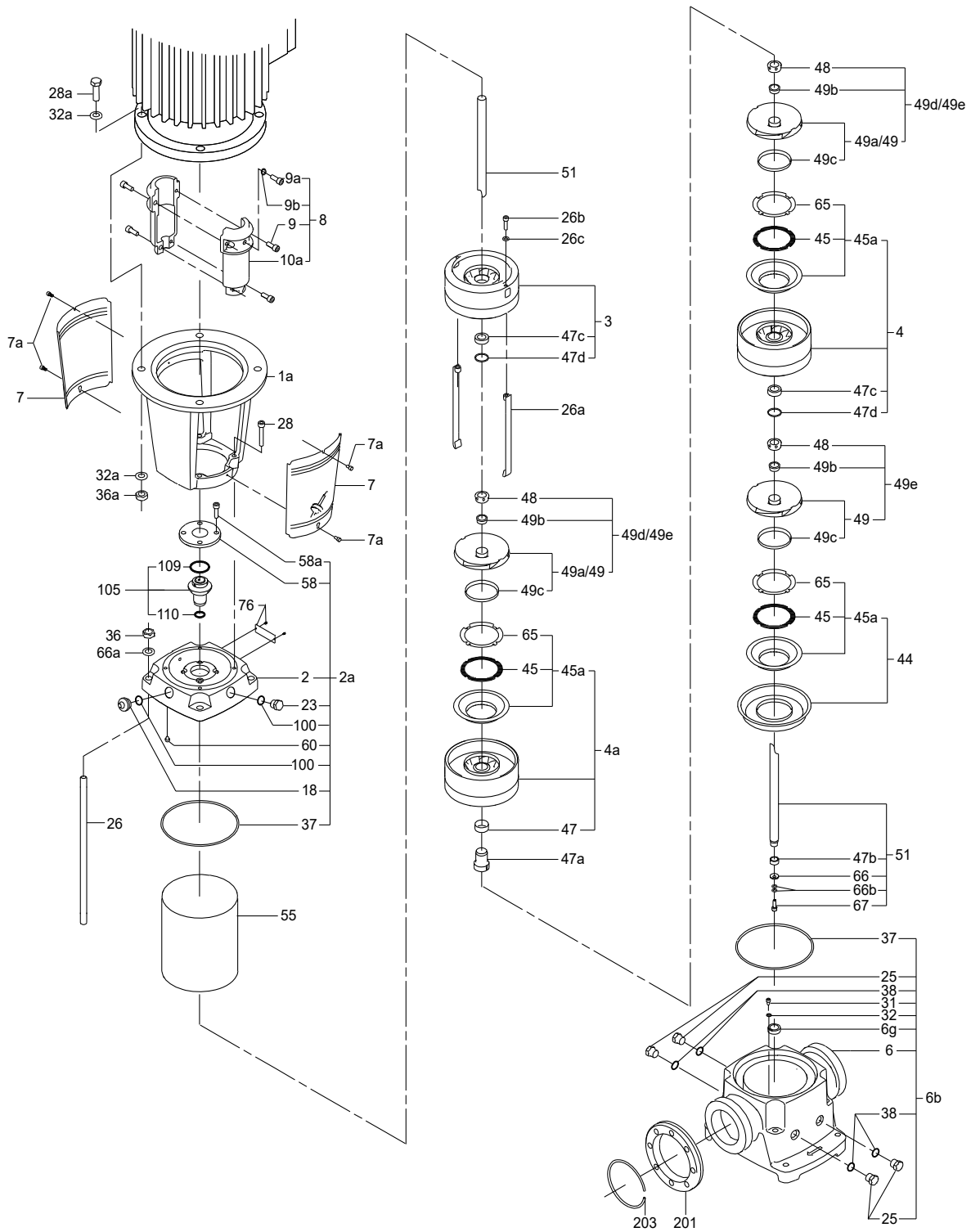

TM022299

## CR, CRN 90, model B

### Chamber stack complete

Pump type	CRN 90	CR 90
90-1	96458125	96416257
90-1-1	96458124	96416256
90-2	96458128	96416260
90-2-1	96458127	96416259
90-2-2	96458126	96416258
90-3	96458131	96416263
90-3-1	96458130	96416262
90-3-2	96458129	96416261
90-4	96458134	96416266
90-4-1	96458133	96416265
90-4-2	96458132	96416264
90-5	96458136	96416269
90-5-1	96493483	96416268
90-5-2	96458135	96416267

Pump type	CRN 90	CR 90
90-6	96458138	96416272
90-6-1	96465601	96416271
90-6-2	96458137	96416270

### Content

Description	Quantity
Rotating assembly	1

### Chamber with bearing

Type	Kit No	
	CR	CRN
SIC/SIC	98497515	98634157
Graflon/HM	98497516	98634158
Bronze/HM	98497517	98634159

### Content

Pos.	Description	Quantity
4a	Chamber cpl.	1
47a	Rotating bearing	1

### Coupling complete

Kit No	96416591	96416592	96416593	96416594	96475477	96475478
Pos. Motor/pump shaft diameter [mm]	38/22	42/22	48/22	55/22	42/22	48/22
Description	For shafts with key and keyway					
10a Coupling half	2	2	2	2	2	2
9 Hexagon socket head screw	4	4	4	4	4	4
9a Hexagon socket head screw	-	-	-	-	1	1
9b Washer	-	-	-	-	1	1
Adjusting fork	1	1	1	1	1	1

### Coupling complete NEMA

Motor/pump shaft diameter	Kit No
41.2/22	96417004
47.6/22	96417020

### Content

Pos.	Description	Quantity
10a	Coupling half	2
9	Hexagon socket head screw	4
	Adjusting fork	1

### Coupling guard

Pos.	Kit No	96505134	96505135
	Description	MG 90 - MG 132	MG 160 - MG 225
7	Coupling guard	2	2
7a	Screw	4	4

### Impeller

Kit No	
CR	CRN
98497518	98635108

### Content

Pos.	Description	Quantity
49	Impeller	1
48	Nut	1
48	Nut with slot	1
49b	Split cone	1

### Impeller reduced

Kit No	
CR	CRN
98635110	98635123

### Content

Pos.	Description	Quantity
49	Impeller	1
48	Nut	1
48	Nut with slot	1
49b	Split cone	1

### Impeller 1. stage

Type	Standard	Reduced
Standard	98593752	98593755
Teflon	98593759	98593761
Electro pol.	98593764	98593769

**Content**

<b>Pos.</b>	<b>Description</b>	<b>Quantity</b>
49	Impeller	1
44	Suction interconnector	1
48	Nut for hub with spring	1

CR, CRN 90, model B

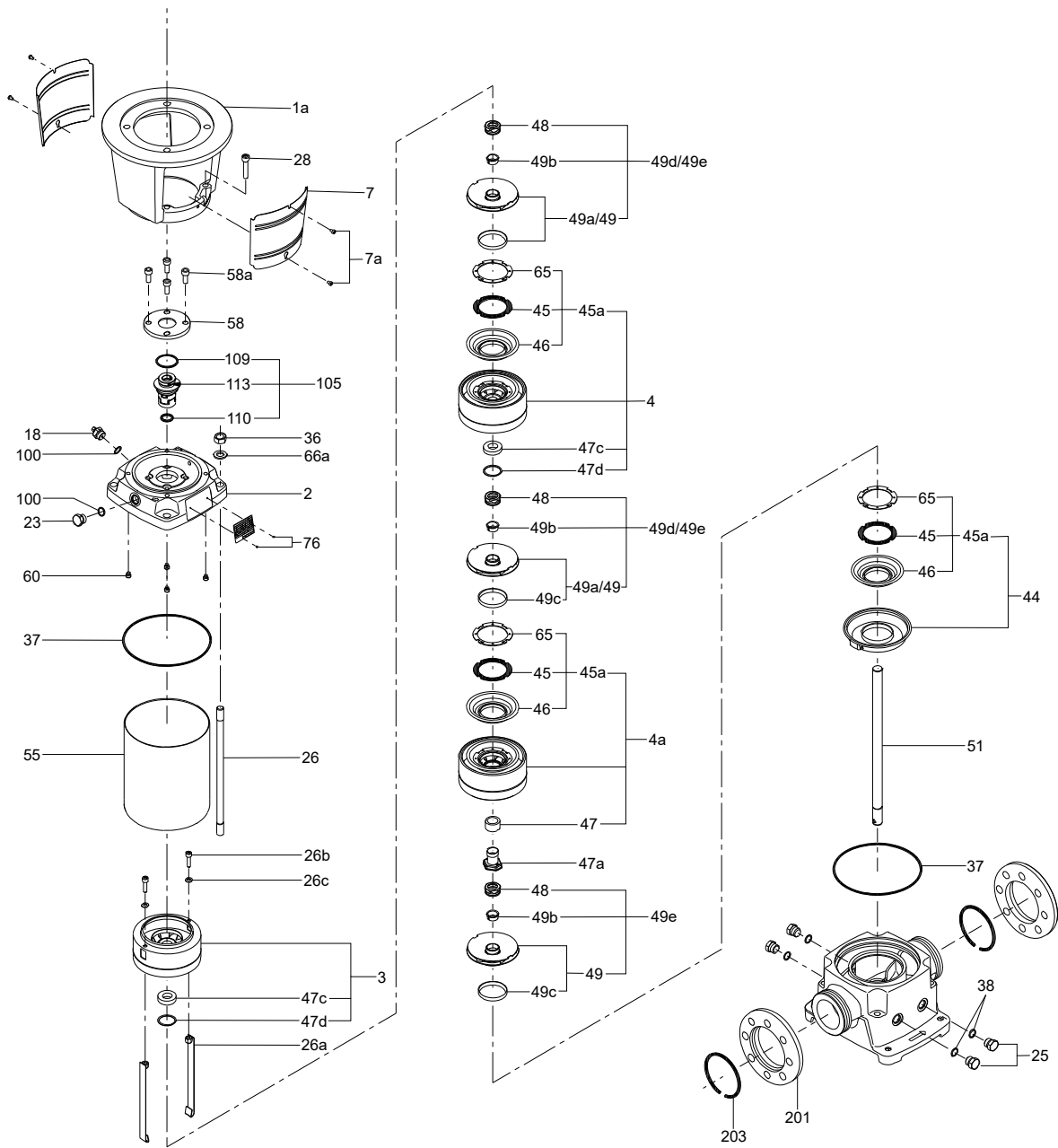

TM060570

**O-ring**

Description	Kit No
EPDM	96416601
FKM	96416602

**Content**

Pos.	Description	Quantity
37	O-ring	2
38	O-ring	4
60	Spring (rubber)	4
100	O-ring	2
109	O-ring	1
110	O-ring	1
-	Adjusting fork (shaft seal)	1

**Plug**

Pos.	Kit No	Description	EPDM/FKM
18	96505136	Vent screw	1
23		Pipe plug	1
25		Pipe plug	4
38		O-ring 16.3 x 2.4	4
100		O-ring 16.3 x 2.4	2

**Shaft seal**

Description	Kit No
HQQE	96525458
HQQV	96525490
HQQK	96533369
HQQF	96533412
HQBE	96525457
HQBV	96525459
HUBK	96533365
HUBF	96533366
HUUE	96436727
HUUV	96436728
HUUK	96533367
HUUF	96533368

**Content**

Pos.	Description	Quantity
105	Shaft seal	1

**Spare chamber**

Type	Kit No	
	CR	CRN
Graflon	98497519	98635126
Teflon	98497520	98635129
Bronze	98497521	98497521

**Content**

Pos.	Description	Quantity
4	Chamber with bush	1

**Spare upper chamber**

Type	Kit No	
	CR	CRN
Graflon	98635130	98635152

Type	Kit No	
	CR	CRN
Teflon	98635142	98635157
Bronze	98635145	98635145

**Content**

Pos.	Description	Quantity
3	Upper chamber with bush	1

**Wear parts**

Type	Kit No	
	CR	CRN
Graflon	1-2	98497509
	3-6	98497510
Teflon	1-2	98497511
	3-6	98497512
Bronze	1-2	98497513
	3-6	98497514

**Content**

Pos.	Description	Stages	Quantity
45	Seal ring	1-2	2
		3-6	6
47c	Bush	1-2	1
		3-6	4
47d	Lock ring	1-2	2
		3-6	6
49c	Wear ring	1-2	1
		3-6	5
-	Wear ring, N	1-2	1
		3-6	1
65	Top for neck ring N	1-2	2
		3-6	6
-	Adjusting fork	1-2	1
		3-6	1

**Upper chamber with bearing**

Type	Kit No	
	CR	CRN
SIC/SIC	98634160	98635099
HY49/HM	98635091	98635100
Bronze/HM	98635095	98635104

**Content**

Pos.	Description	Quantity
3	Upper chamber cpl.	1
47a	Bearing cpl.	1

CR, CRN 90, model B

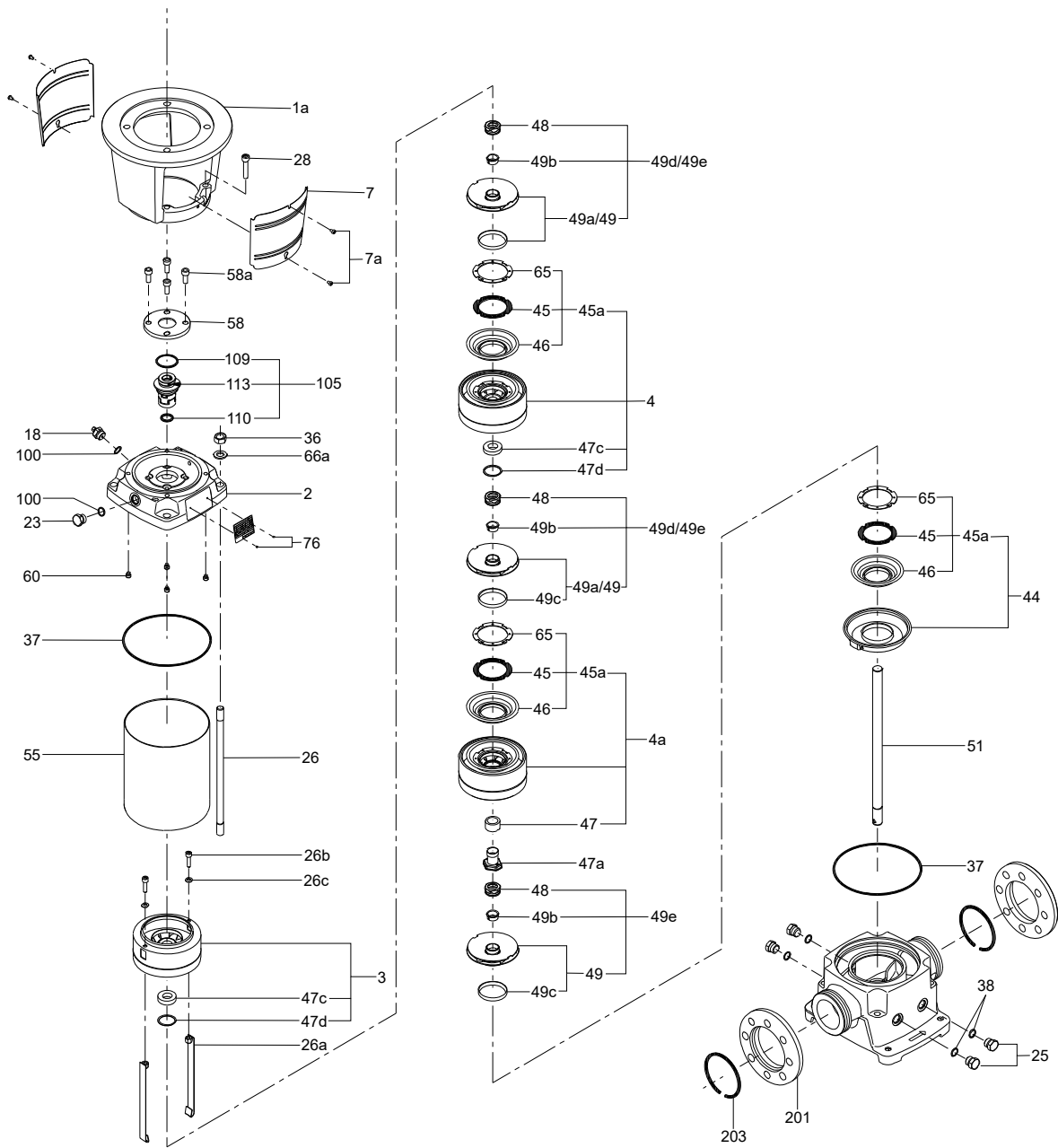

TM060570

## CR, CRN 120, 150 50/60 Hz

### Bearing

Pos.	Description / number of stages	1-7
	Kit No	<a href="#">96752215</a>
47b	Bearing ring, rotating	1
	Adjusting fork	2
47e	Washer	2

### Coupling guard

Pos.	Description	MG 160 - MMG 280S / 254 TC - 405 TSC
	Kit No	<a href="#">96505135</a>
7	Coupling guard	2
7a	Screw	4

### O-ring

Pos.	Description	EPDM		FKM	
		Kit No	<a href="#">95059804</a>	Kit No	<a href="#">95059805</a>
37	O-ring	2	2		
38	O-ring	4	4		
60	Spring (PTFE)	4	4		
100	O-ring	2	2		
109	O-ring	22 mm shaft seal	1	1	
		32 mm shaft seal	1	1	
110	O-ring	22 mm shaft seal	1	1	
		32 mm shaft seal	1	1	
	Adjusting fork	∅22	1	1	
	Adjusting fork	∅32	1	1	

### Shaft seal

#### 22 mm

Description	Kit No
HQQE	<a href="#">96525458</a>
HQQV	<a href="#">96525490</a>
HQQK	<a href="#">96533369</a>
HQQF	<a href="#">96533412</a>
HQBE	<a href="#">96525457</a>
HQBV	<a href="#">96525459</a>
HUBK	<a href="#">96533365</a>
HUBF	<a href="#">96533366</a>
HUUE	<a href="#">96436727</a>

Description	Kit No
HUUV	<a href="#">96436728</a>
HUUK	<a href="#">96533367</a>
HUUF	<a href="#">96533368</a>

### Content

Pos.	Description	Quantity
105	Shaft seal	1

### 22 mm, de-oiled

Description	Kit No
HUUE	<a href="#">96502869</a>
HQQE	<a href="#">96881983</a>
HUUK	<a href="#">96502911</a>
HQQK	<a href="#">96502912</a>
HUUV	<a href="#">96124905</a>
HQQV	<a href="#">96124906</a>

### Content

Pos.	Description	Quantity
105	Shaft seal	1

### 32 mm

Description	Kit No
HBQE	<a href="#">95059800</a>
HBQV	<a href="#">95059801</a>
HQQE	<a href="#">95059802</a>
HQQV	<a href="#">95059803</a>

### Content

Pos.	Description	Quantity
105	Shaft seal	1

### 32 mm, de-oiled

Description	Kit No
HQQE	<a href="#">95059876</a>
HQQV	<a href="#">95059877</a>

### Content

Pos.	Description	Quantity
105	Shaft seal	1

## Wear parts

Pos.	Description / number of stages	CR, CRN 120			CR, CRN 150		
		1	2-4	5-7	1	2-3	4-6
	Kit No	95059806	95059807	95059808	95059809	95059810	95059811
7a	Screw	3	12	21	3	9	18
45	Seal ring (PTFE)	-	3	6	-	2	5
45b	Seal ring (PTFE)	1	1	1	1	1	1
47b	Bearing ring, rotating	1	1	1	1	1	1
47c	Support bearing (HY49)	-	3	6	-	2	5
47d	Lock ring	-	6	12	-	4	10
47e	Washer	2	2	2	2	2	2
65	Seal retainer	-	3	6	-	2	5
65a	Seal retainer	1	1	1	1	1	1
72	Wear ring	1	4	7	1	3	6
-	Adjusting fork	1	2	2	1	2	2



CR, CRN 120, 150

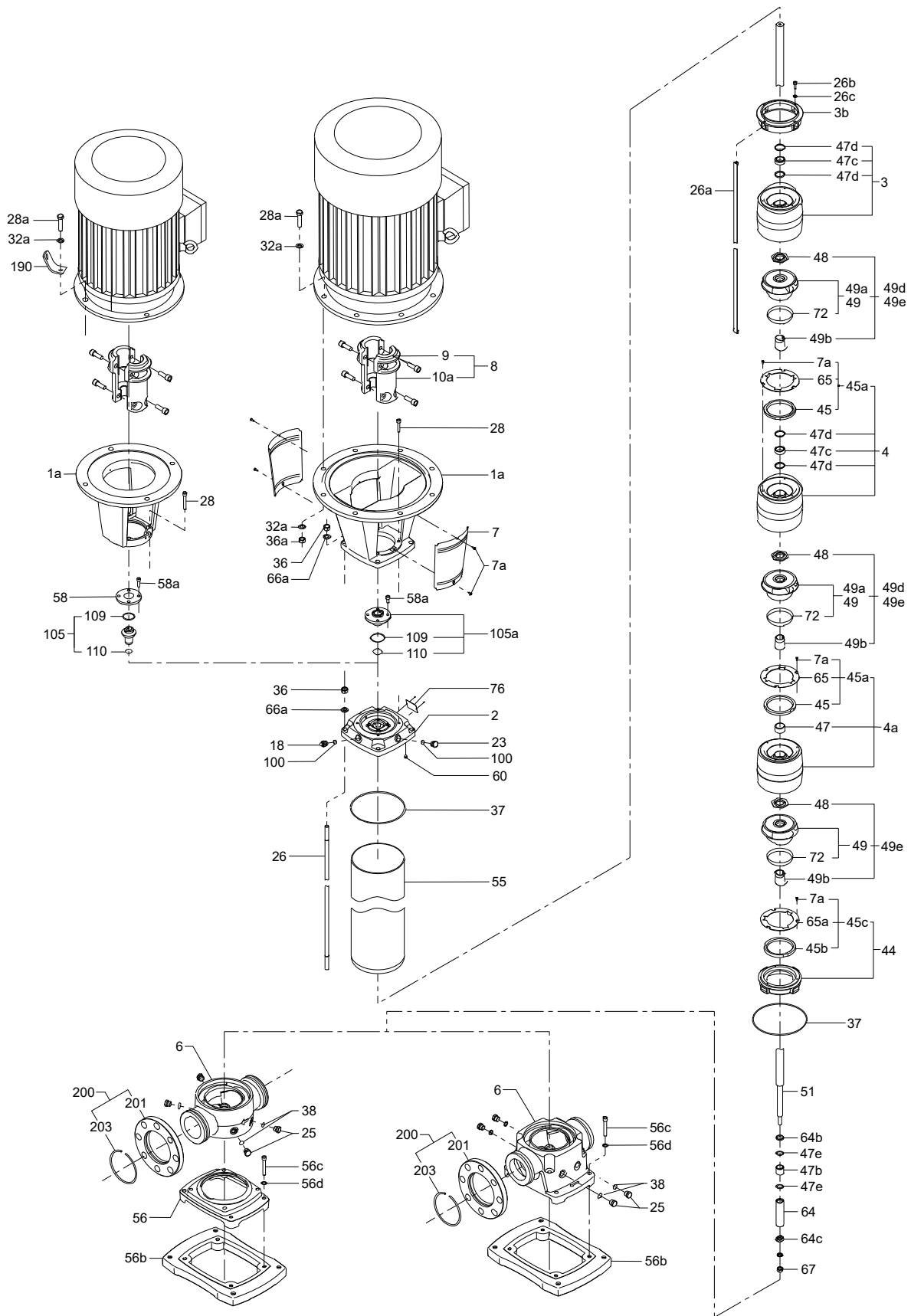

TM036001

## Chamber stack complete

Pump type	120-1-1	120-1	120-2-2	120-2-1	120-2	120-3-2	120-3-1	120-3	120-3	120-4-2	120-4-2	120-4-1
	< 55 kW	< 55 kW	< 55 kW	< 55 kW	< 55 kW	< 55 kW	< 55 kW	< 55 kW	≥ 55 kW	< 55 kW	≥ 55 kW	< 55 kW
CR 120	96925133	95059816	95059817	95059818	95059819	96925134	95059820	95059821	95059868	96798242	95059822	95059823
CRN 120	96925135	95059829	95059830	95059831	95059832	96925136	95059833	95059834	95059871	96798247	95059835	95059836
Chamber stack	1	1	1	1	1	1	1	1	1	1	1	1

Pump type	120-4-1	120-4	120-4	120-5-2	120-5-2	120-5-1	120-5-1	120-6-1	120-6-1	120-7	120-7
	≥ 55 kW	< 55 kW	≥ 55 kW	< 55 kW	≥ 55 kW	< 55 kW	≥ 55 kW	< 55 kW	≥ 55 kW	< 55 kW	≥ 55 kW
CR 120	95059869	96798243	95059824	96798244	95059870	95059825	95059826	96798245	95059827	96798246	95059828
CRN 120	95059872	96798248	95059837	96798249	95059873	95059838	95059839	96798250	95059840	96798251	95059841
Chamber stack	1	1	1	1	1	1	1	1	1	1	1

Pump type	150-1-1	150-1	150-2-2	150-2-1	150-2	150-3-1	150-3-1	150-3-2	150-3-2	150-3
	< 55 kW	< 55 kW	< 55 kW	< 55 kW	< 55 kW	< 55 kW	≥ 55 kW	< 55 kW	≥ 55 kW	< 55 kW
CR 150	95059842	95059843	95059844	95059845	95059846	96925137	96925138	95059847	95059848	95059849
CRN 150	95059855	95059856	95059857	95059858	95059859	96925139	96925140	95059860	95059861	95059862
Chamber stack	1	1	1	1	1	1	1	1	1	1

Pump type	150-3	150-4-2	150-4-2	150-4-1	150-4-1	150-5-2	150-5-2	150-6	150-6
	≥ 55 kW	< 55 kW	≥ 55 kW	< 55 kW	≥ 55 kW	< 55 kW	≥ 55 kW	< 55 kW	≥ 55 kW
CR 150	95059850	96798252	95059874	95059851	95059852	96798253	95059853	96798254	95059854
CRN 150	95059863	96798255	95059875	95059864	95059865	96798256	95059866	96798257	95059867
Chamber stack	1	1	1	1	1	1	1	1	1

## Chamber complete with bearing, pos. 47

Pos.	Pump type	120	150	120	150
	For number of stages	1	1	2-7	2-6
	CR	96751986	96751988	96751982	96751984
	CRN	96751987	96751989	96751983	96751985
4a	Chamber with SIC bearing, pos. 47	-	-	1	1
-	Top chamber with SIC bearing, pos. 47	1	1	-	-

## Coupling

Pos.	Motor frame size	MG 160	MMG 180	MMG 200/225	MMG 250M	MMG 280S
	Motor/pump shaft diameter [mm]	42/22	48/22	55/22	60/32	65/32
	Description	IEC	IEC	IEC	IEC	IEC
	Kit No	96416592	96416593	96416594	95059812	95059813
10a	Coupling half	2	2	2	2	2
9	Hexagon socket head screw	4	4	4	4	4
	Adjusting fork	1	1	1	1	1

Pos.	Motor frame size	254/256 TC & 284/286 TSC	324/326 TSC & 364/365 TSC	364/365 TSC	405 TSC
	Motor/pump shaft diameter [mm]	41.2/22	47.55/22	47.55/32	53.9/32
	Description	NEMA	NEMA	NEMA	NEMA
	Kit No	96417004	96417020	95059814	95059815
10a	Coupling half	2	2	2	2
9	Hexagon socket head screw	4	4	4	4
	Adjusting fork	1	1	1	1

**Plug**

Pos.	Kit No	<i>96505136</i>	
	Description	EPDM/FKM	
18	Vent screw	1	
23	Pipe plug	1	
25	Pipe plug	4	
38	O-ring 16.3 x 2.4	4	
100	O-ring 16.3 x 2.4	2	

**Shaft parts**

Pos.	Pump type	120	120/150
	For number of stages	7	
CR			
	Kit no.	<i>97683114</i>	<i>98533480</i>
47b	Bearing	1	-
47e	Washer	2	2
51	Shaft	1	-
64b	Washer	1	1
64	Spacing bush	1	-
64c	Spacer lower	1	1
66b	Washer	1	1
67	Nut	1	1

CR, CRN 120, 150

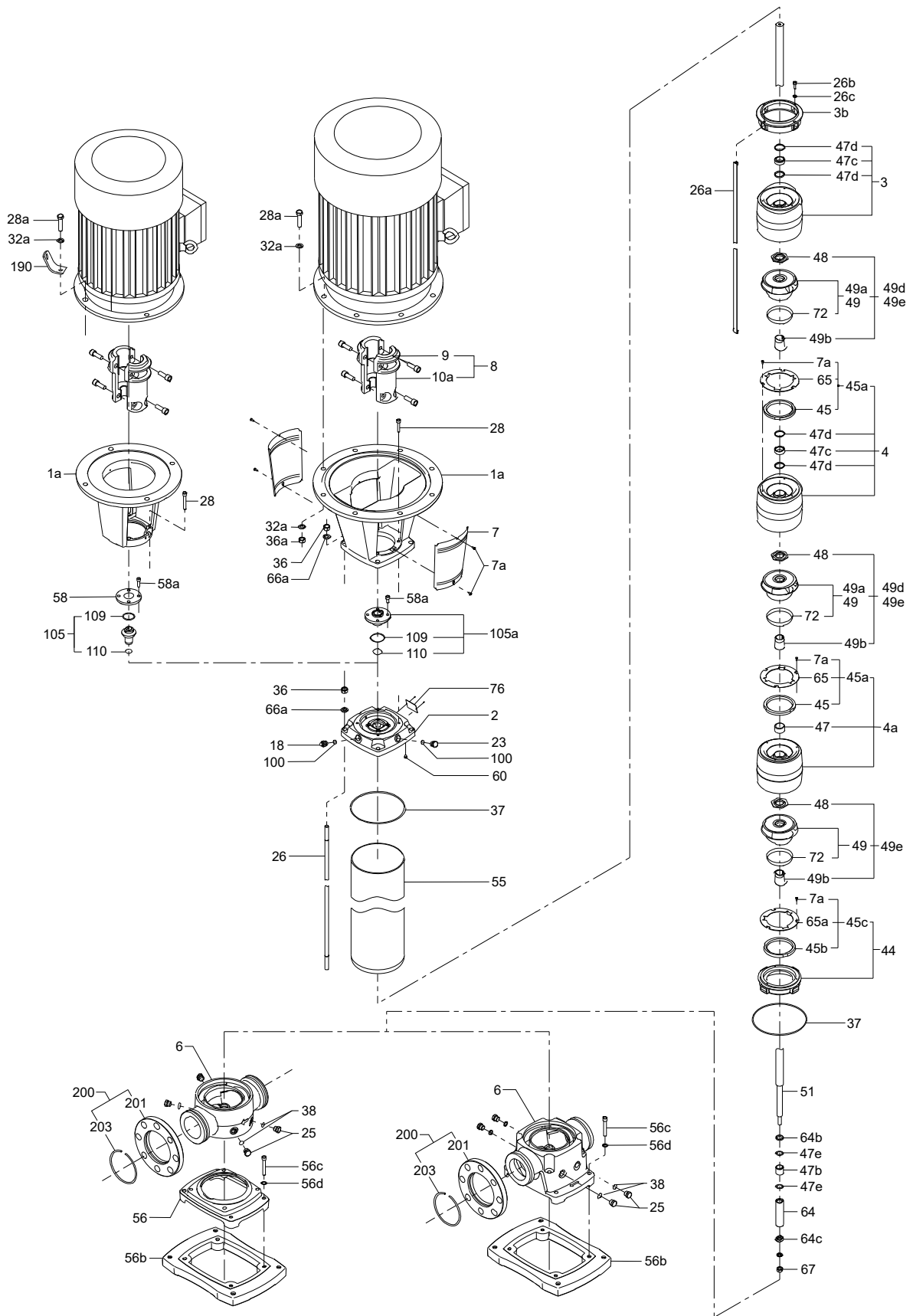

TMO36001